

# Klein®

## ALUKlein

Utensili per alluminio e materie plastiche  
*Tools for aluminium and plastic working*

**23.A**



[www.sistemiklein.com](http://www.sistemiklein.com)

MADE IN ITALY

	PP.		PP.		PP.
	4/5		12		17
PORTAUTENSILI CONO ISO 30 COLLET CHUCKS ISO 30		PROLUNGHE CILINDRICHE PER CONI A CALETTAMENTO A CALDO SHRINK FIT CHUCK EXTENSIONS		CHIAVI WRENCHES	
	4		12		17
PORTAUTENSILI CONO ISO 30 TIPO PROLUNGATO COLLET CHUCKS ISO 30		PROLUNGHE CILINDRICHE PORTAPINZE STRAIGHT SHANK TOOL EXTENSIONS		CHIAVI DINAMOMETRICHE PER GHIERE "MINI" TORQUE WRENCHES FOR "MINI" NUTS	
	5		13		17
PORTAUTENSILI CONO HSK-40A COLLET CHUCKS HSK-40A		PORTAUTENSILI INOX CONO ISO 30 COLLET CHUCKS ISO 30 INOX		CHIAVI DINAMOMETRICHE PER GHIERE "STANDARD" TORQUE WRENCHES FOR "STANDARD" NUT	
	6		13		17
PORTAUTENSILI CONO HSK-63F COLLET CHUCKS HSK-63F		PORTAUTENSILI INOX CONO HSK-63F COLLET CHUCKS HSK-63F INOX		CHIAVI DINAMOMETRICHE A SETTORE TORQUE HOOK WRENCHES	
	6		14		18
PORTAUTENSILI CONO HSK-50F COLLET CHUCKS HSK-50F		MASCHIATORI ISO 30 A CAMBIO RAPIDO QUICK CHANGE ISO 30 TAPPING CHUCK		SMONTACOMUNI UNIVERSALE REGOLABILE ADJUSTABLE DEMOUNT DEVICES	
	6		14		18
VITE ANTIPOLVERE DUST PLUG		MASCHIATORI HSK-63F A CAMBIO RAPIDO QUICK CHANGE HSK-63F TAPPING CHUCK		KIT PULIZIA WIPE OFF KIT	
	7		14		18
PORTAUTENSILI CONO HSK FORMA "E" COLLET CHUCKS HSK "E"		BUSSOLE PORTAMASCHI A CAMBIO RAPIDO DIN 371 QUICK CHANGE BUSHES FOR TAPPING (DIN 371)		BARRE DI CONTROLLO PRECISION TEST BARS	
	7		14		19
PORTAUTENSILI CONO HSK-63E COLLET CHUCKS HSK-63E		BUSSOLE PORTAMASCHI A CAMBIO RAPIDO DIN 371 CON FRIZIONE QUICK CHANGE BUSHES FOR TAPPING (DIN 371) WITH SAFETY CLUTCH		FRESE CON COLTELLINI HW PER MATERIALI PLASTICI HW INSERT ROUTER BITS FOR PLASTIC MATERIAL	
	7		15		19
TIRANTI PER CONI PORTAUTENSILI RETAINING PAWLS FOR CONCENTRIC CHUCK		PINZE ER 32 - DIN 6499 SPRING COLLETS ER 32 DIN 6499		FRESE CON COLTELLINI HW PER FRESARE A "V" MATERIALI PLASTICI Z=1 HW INSERT V-GROOVE ROUTER BITS Z=1 FOR PLASTIC <b>Klein</b> DA	
	8		15		20
PORTAUTENSILI CONO HSK-63F ER16/ER32 - G 2,5 COLLET CHUCKS HSK-63F ER16/ER32 - G 2,5		SET DI PINZE ER 32 - DIN 6499 SPRING COLLETS SET ER 32 DIN 6499		FRESE HW INTEGRALE ELICA SINISTRA Z=1 SOLID CARBIDE SPIRAL BITS DOWN CUT Z=1	
	8		15		20
GHIERE PER MANDRINI COLLET NUTS		PINZE ER 40 - DIN 6499 SPRING COLLETS SET ER 40 DIN 6499		FRESE HW INTEGRALE ELICA DESTRA Z=1 SOLID CARBIDE SPIRAL BITS UP CUT Z=1	
	9		15		20
GHIERA CONVOGLIATORE DUST & CHIP EXTRACTION NUT		SET DI PINZE ER 40 - DIN 6499 SPRING COLLETS SET ER 40 DIN 6499		FRESE HW INTEGRALE ELICA DESTRA Z=1 - Z=2 SOLID CARBIDE SPIRAL BITS UP CUT Z=1 - Z=2	
	9/10		16		21
ADATTATORE PER SEGHE CIRCOLARI ADAPTER FOR CIRCULAR SAWBLADES		PINZE ER 25 - DIN 6499 SPRING COLLETS ER 25 DIN 6499		FRESE HW INTEGRALE ELICA DESTRA Z=2 SOLID CARBIDE SPIRAL BITS UP CUT Z=2	
	11		16		21
PORTAUTENSILI CONO HSK-63F PER CALETTAMENTO A CALDO SHRINK FIT CHUCKS HSK-63F		PINZE ER 20 - DIN 6499 SPRING COLLETS ER 20 DIN 6499		FRESE HW INTEGRALE ELICA DESTRA Z=1 SOLID CARBIDE SPIRAL BITS UP CUT Z=1 <b>Klein</b> DA	
	11		16		22
PORTAUTENSILI CONO ISO 30 PER CALETTAMENTO A CALDO SHRINK FIT CHUCKS ISO 30		PINZE ER 16 - DIN 6499 SPRING COLLETS ER 16 DIN 6499		FRESE HW INTEGRALE ELICA SINISTRA Z=1 SOLID CARBIDE SPIRAL BITS DOWN CUT Z=1 <b>Klein</b> DA	
	11		16		22
STAZIONE PER CALETTAMENTO SHRINK FIT UNIT		PINZE ER 11 - DIN 6499 SPRING COLLETS ER 11 DIN 6499		FRESE HW INTEGRALE ELICA DESTRA Z=2 SOLID CARBIDE SPIRAL BITS UP CUT Z=2 <b>Klein</b> DA	
	11		17		22
MODULO DI RAFFREDDAMENTO AD ARIA COOLING UNIT WITH AIR FLOW		PINZE ER 32 - DIN 6499 A TENUTA STAGNA WATER-TIGHT SPRING COLLETS ER 32 - DIN 6499		FRESE HW INTEGRALE ELICA DESTRA Z=1 - Z=2 SOLID CARBIDE SPIRAL BITS UP CUT Z=1 - Z=2 <b>Klein</b> DA	

	<b>FRESE HW A "T" Z=4</b> T-SLOT HW CUTTERS Z=4	22		<b>FRESE HS A TAGLIENTE DIRITTO</b> PER PVC Z=1 HS SPECIAL BITS FOR PVC Z=1	28		<b>LAME CIRCOLARI HW</b> PER ALLUMINIO HW POSITIVE SAWBLADES FOR ALUMINIUM	Xtra cut	35
	<b>FRESE HW INTEGRALE ELICA DESTRA</b> Z=5 PER SUPERFINITURA SOLID CARBIDE SPIRAL CUTTERS Z=5 SUPER-FINISHING	23		<b>FRESE HS A TAGLIENTE ELICOIDALE</b> PER PVC Z=2 HS SPECIAL BITS FOR PVC Z=2	28		<b>LAME CIRCOLARI HW</b> PER ALLUMINIO HW NEGATIVE SAWBLADES FOR ALUMINIUM	Xtra cut	36
	<b>FRESE HW INTEGRALE</b> PER VETRORESINA SOLID CARBIDE BITS FOR FIBERGLASS WORKING	23		<b>FRESE HS A TAGLIANTI ELICOIDALI</b> PER ALLUMINIO Z=2, Z=3 HS UPCUT SPIRAL CUTTERS FOR ALUMINIUM Z=2, Z=3	28		<b>LAME CIRCOLARI HW</b> PER PVC HW SAWBLADES FOR PVC	Xtra cut	37
	<b>FRESE HW INTEGRALE</b> ELICA DESTRA Z=2 SOLID CARBIDE SPIRAL BITS DOWN CUT Z=2	23		<b>PUNTE HS PER FORARE PVC</b> E ALLUMINIO Z=2 HS DRILLING BITS FOR PVC AND ALUMINIUM WORKING Z=2	28		<b>LAME CIRCOLARI DI PRECISIONE HW</b> HW CIRCULAR SAWBLADES FOR BILAMINATED PANELS	Xtra cut	37
	<b>FRESE HW INTEGRALE</b> ELICA DESTRA Z=4 SOLID CARBIDE SPIRAL BITS DOWN CUT Z=4	23		<b>PUNTE HS PER FORARE PVC</b> E ALLUMINIO Z=2 HS DRILLING BITS FOR PVC AND ALUMINIUM WORKING Z=2	29		<b>LAME CIRCOLARI DI PRECISIONE HW</b> HW CIRCULAR SAWBLADES FOR BILAMINATED PANELS		38
	<b>FRESE A DUE DIAMETRI IN HW</b> INTEGRALE ELICA DESTRA Z=1 SOLID CARBIDE DOUBLE DIAMETER SPIRAL BITS Z=1	23		<b>FRESE HW PER LAVORAZIONE</b> ALUCOBOND® Z=2 HW DRILLS FOR WORKING ALUCOBOND® Z=2	29		<b>LAME CIRCOLARI DI PRECISIONE HW</b> HW TRIMMING AND SIZING SAWBLADES		38
	<b>FRESE HW INTEGRALE ELICA DESTRA</b> Z=1 - Z=2 TIPO PUNGO SOLID CARBIDE SPIRAL BITS UP CUT Z=1 - Z=2 LONG TYPE	24		<b>PUNTE PER CERNIERE IN</b> HW PER ALLUMINIO Z=2 HW HINGE BORING BITS FOR ALUMINIUM Z=2	29		<b>LAME CIRCOLARI HW "QUATTRO" O "DRY"</b> HW "DRY" OR "QUATTRO" SAWBLADES		39
	<b>FRESE HW INTEGRALE ELICA DESTRA</b> Z=1 TIPO CORTO SOLID CARBIDE SPIRAL BITS UP CUT Z=1 - SHORT TYPE	24		<b>PUNTE HS A DUE DIAMETRI</b> PER ALLUMINIO Z=2 HS DOUBLE DIAMETER SPIRAL BITS FOR ALUMINIUM Z=2	29		<b>LAME CIRCOLARI HW PER SOLID SURFACE</b> HW SAWBLADES FOR SOLID SURFACE AND CHIPBOARD PANELS		39
	<b>FRESE HW INTEGRALE ELICA DESTRA</b> Z=1 - Z=2 TIPO PUNGO SOLID CARBIDE SPIRAL BITS UP CUT Z=1 - Z=2 LONG TYPE	25		<b>CANNOTTI PORTAFRESE</b> HOLDING SLEEVES	29/30		<b>LAME CIRCOLARI HW PER PLEXIGLASS</b> HW SAWBLADES FOR PVC AND PLEXIGLASS		40
	<b>FRESE HW INTEGRALE ELICA DESTRA</b> Z=1 TIPO CORTO SOLID CARBIDE SPIRAL BITS UP CUT Z=1 - SHORT TYPE	25		<b>ANELLI DISTANZIALI</b> SPACERS	30		<b>LAME CIRCOLARI IN PKD PER TAGLIO</b> MATERIALI ABRASIVI HW SAWBLADES FOR CUTTING ABRASIVE MATERIALS		40
	<b>FRESE HS-E ELICOIDALI</b> PER ALLUMINIO Z=1 HS UPCUT SPIRAL BITS FOR ALUMINIUM Z=1	26		<b>GRUPPI PROGRAMMATI PER</b> LAVORARE PROFILATI ALLUMINIO SPECIAL UNITS FOR ALUMINIUM-PROFILES	30		<b>PRE SET P368LR</b> PRE SET P368 LR		41
	<b>FRESE HS-E ELICOIDALI PER</b> ALLUMINIO TIPO LUNGO Z=1 HS UPCUT SPIRAL BITS FOR ALUMINIUM Z=1	26		<b>FRESE HW A DENTI ALTERNI</b> HW ALTERNATE TOOTH MILLING CUTTERS	30		<b>CALIBRI</b> GAUGES		42
	<b>SET DI FRESE PER ALLUMINIO</b> SET FOR ALU	26		<b>FRESE HW PER LAVORAZIONE</b> ALUCOBOND® CARBIDE TIPPED MILLING CUTTERS FOR ALUCOBOND® AND ACM	31		<b>ANGOLFAST</b> ANGOLFAST		42
	<b>FRESE HS-E ELICOIDALI</b> PER ALLUMINIO Z=1 HS UPCUT SPIRAL BITS FOR ALUMINIUM Z=1	27		<b>FRESE HW INTEGRALI A TAGLIANTI DIRITTI</b> PER LAVORAZIONE ALUCOBOND® VHW STRAIGHT BITS FOR WORKING ALUCOBOND®	31		<b>TRIMATIC</b> DRILLING		43
	<b>FRESE HS-E ELICOIDALI PER</b> ALLUMINIO Z=1 TIPO LUNGO HS UPCUT SPIRAL BITS FOR ALUMINIUM Z=1 LONG TYPE	27		<b>LAME CIRCOLARI</b> PER SEGHE PORTATILI HW SAWBLADES FOR PORTABLE MACHINES	32				
	<b>FRESE HW INTEGRALE</b> ELICA DESTRA Z=2 SOLID CARBIDE SPIRAL CUTTERS Z=2	27		<b>LAME CIRCOLARI</b> PER SEGHE PORTATILI HW SAWBLADES FOR PORTABLE MACHINES	32				
	<b>FRESE HS A DUE DIAMETRI</b> PER ALLUMINIO Z=2 HS DOUBLE DIAMETER SPIRAL BITS FOR ALUMINIUM Z=2	28		<b>LAME PROFESSIONALI A</b> SPESSORE SOTTILE EXTRA THIN KERF PROFESSIONAL SAWBLADES	33				

## PORTAUTENSILI CONO ISO 30/COLLET CHUCKS ISO 30

ART. T118

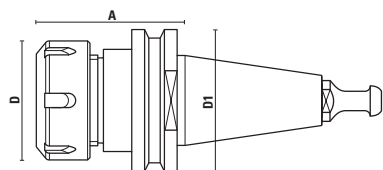

- Viene fornito completo di ghiera e tirante (senza pinza)
- Ghiera DIN 6499
- La quota "A" è rilevata con l'utensile montato su nostra pinza DIN6499. Da notare che la quota "A" può subire variazioni in base al diametro dell'utensile in pinza
- Supplied with nut (without collet) and retaining pawl
- Threaded nut DIN 6499
- The "A" measure will be determined with clamped tool shanks by using our spring collet DIN6499. The "A" measure may be subject to variations depending on the diameter of the clamped tools

- Tirante/Retaining pawl T118.891.R (motori/motor H.S.D.)

Articolo/Item	A	D	D1	Pinze/Spring collets	Ghiera/Clamping nut	Rot.
T118.796.R	50	32	50	2÷10 (Art. T127/ER16)	Z091.105.R	Dx/Rh
T118.797.R	50	35	50	2÷12 (Art. T126/ER20)	Z091.104.R	Dx/Rh
T118.798.R	50	42	50	3÷16 (Art. T125/ER25)	Z091.103.R	Dx/Rh

## PORTAUTENSILI CONO ISO 30/COLLET CHUCKS ISO 30

ART. T118

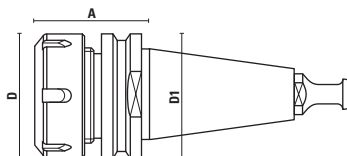

- Viene fornito completo di ghiera e tirante (senza pinza)
- Ghiera DIN 6499
- La quota "A" è rilevata con l'utensile montato su nostra pinza DIN6499. Da notare che la quota "A" può subire variazioni in base al diametro dell'utensile in pinza.
- Supplied with nut (without collet) and retaining pawl
- Threaded nut DIN 6499
- The "A" measure will be determined with clamped tool shanks by using our spring collet DIN6499. The "A" measure may be subject to variations depending on the diameter of the clamped tools

- Tirante/Retaining pawl T118.891.R (motori/motor H.S.D.)

Articolo/Item	A	D	D1	Pinze/Spring collets	Ghiera/Clamping nut	Rot.
T118.800.R	50	50	50	2÷20 (Art. T119/ER32)	Z091.001.R	Dx/Rh
T118.800.L	50	50	50	2÷20 (Art. T119/ER32)	Z091.001.L	Sx/Lh
T118.802.R	50	50	50	2÷20 (Art. T119/ER32)	Z091.101.R c/cuscinetto/ball bearing nut	Dx/Rh
T118.830.R	60	63	50	2÷30 (Art. T123/ER40)	Z091.002.R	Dx/Rh
T118.830.L	60	63	50	2÷30 (Art. T123/ER40)	Z091.002.L	Sx/Lh
T118.832.R	60	63	50	2÷30 (Art. T123/ER40)	Z091.102.R c/cuscinetto/ball bearing nut	Dx/Rh

## PORTAUTENSILI CONO ISO 30 TIPO PROLUNGATO/COLLET CHUCKS ISO 30

ART. T118

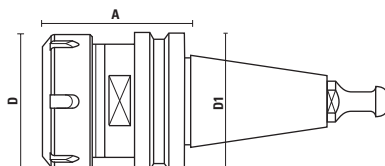

- Viene fornito completo di ghiera e tirante (senza pinza)
- Ghiera DIN 6499
- La quota "A" è rilevata con l'utensile montato su nostra pinza DIN6499. Da notare che la quota "A" può subire variazioni in base al diametro dell'utensile in pinza.
- Supplied with nut (without collet) and retaining pawl
- Threaded nut DIN 6499
- The "A" measure will be determined with clamped tool shanks by using our spring collet DIN6499. The "A" measure may be subject to variations depending on the diameter of the clamped tools

- Tirante/Retaining pawl T118.891.R (motori/motor H.S.D.)

Articolo/Item	A	D	D1	Pinze/Spring collets	Ghiera/Clamping nut	Rot.
T118.804.R	68	50	50	2÷20 (Art. T119/ER32)	Z091.001.R	Dx/Rh
T118.804.L	68	50	50	2÷20 (Art. T119/ER32)	Z091.001.L	Sx/Lh
T118.806.R	68	50	50	2÷20 (Art. T119/ER32)	Z091.101.R c/cuscinetto/ball bearing nut	Dx/Rh
T118.834.R	68	63	50	2÷30 (Art. T123/ER40)	Z091.002.R	Dx/Rh
T118.834.L	68	63	50	2÷30 (Art. T123/ER40)	Z091.002.L	Sx/Lh
T118.836.R	68	63	50	2÷30 (Art. T123/ER40)	Z091.102.R c/cuscinetto/ball bearing nut	Dx/Rh

## PORTAUTENSILI CONO ISO 30/ COLLET CHUCKS ISO 30

ART. T118

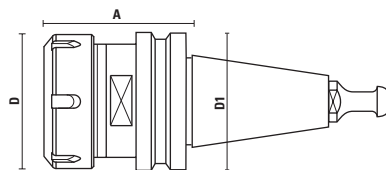

- Viene fornito completo di ghiera e tirante (senza pinza)
- Ghiera DIN 6388 (EOC25)
- La quota "A" è rilevata con l'utensile montato su nostra pinza DIN 6388 (EOC25). Da notare che la quota "A" può subire variazioni in base al diametro dell'utensile in pinza.

- Supplied with nut (without collet) and retaining pawl
- Threaded nut DIN 6388 (EOC25)
- The "A" measure will be determined with clamped tool shanks by using our spring collet DIN 6388 (EOC25). The "A" measure may be subject to variations depending on the diameter of the clamped tools.

- Tirante/Retaining pawl T118.791.R (DIN 69872)

Articolo/Item	A	D	D1	Pinze/Spring collets	Ghiera/Clamping nut	Rot.
T118.828.R	68	60	50	3÷25 (Art. T124/EOC25)	Z091.202.R	Dx/Rh
T118.829.R	68	60	50	3÷25 (Art. T124/EOC25)	Z091.203.R c/cuscinetto/ball bearing nut	Dx/Rh

- Tirante/Retaining pawl T118.891.R (motori/motor H.S.D.)

Articolo/Item	A	D	D1	Pinze/Spring collets	Ghiera/Clamping nut	Rot.
T118.838.R	68	60	50	3÷25 (Art. T124/EOC25)	Z091.202.R	Dx/Rh
T118.839.R	68	60	50	3÷25 (Art. T124/EOC25)	Z091.203.R c/cuscinetto/ball bearing nut	Dx/Rh

## PORTAUTENSILI CONO ISO 30/ COLLET CHUCKS ISO 30

ART. T118

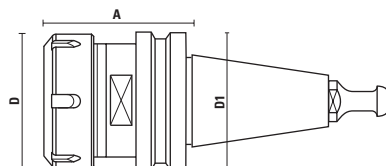

- Viene fornito completo di ghiera e tirante (senza pinza)
- Ghiera DIN 6499
- La quota "A" è rilevata con l'utensile montato su nostra pinza DIN6499. Da notare che la quota "A" può subire variazioni in base al diametro dell'utensile in pinza.

- Supplied with nut (without collet) and retaining pawl
- Threaded nut DIN 6499
- The "A" measure will be determined with clamped tool shanks by using our spring collet DIN6499. The "A" measure may be subject to variations depending on the diameter of the clamped tools.

- Tirante/Retaining pawl T118.792.R

Articolo/Item	A	D	D1	Pinze/Spring collets	Ghiera/Clamping nut	Rot.
T118.810.R	68	50	50	2÷20 (Art. T119/ER32)	Z091.001.R	Dx/Rh
T118.810.L	68	50	50	2÷20 (Art. T119/ER32)	Z091.001.L	Sx/Lh
T118.812.R	68	50	50	2÷20 (Art. T119/ER32)	Z091.101.R c/cuscinetto/ball bearing nut	Dx/Rh
T118.814.R	68	63	50	2÷30 (Art. T123/ER40)	Z091.002.R	Dx/Rh
T118.814.L	68	63	50	2÷30 (Art. T123/ER40)	Z091.002.L	Sx/Lh
T118.816.R	68	63	50	2÷30 (Art. T123/ER40)	Z091.102.R c/cuscinetto/ball bearing nut	Dx/Rh

- Tirante/Retaining pawl T118.791.R (DIN 69872)

Articolo/Item	A	D	D1	Pinze/Spring collets	Ghiera/Clamping nut	Rot.
T118.820.R	68	50	50	2÷20 (Art. T119/ER32)	Z091.001.R	Dx/Rh
T118.820.L	68	50	50	2÷20 (Art. T119/ER32)	Z091.001.L	Sx/Lh
T118.822.R	68	50	50	2÷20 (Art. T119/ER32)	Z091.101.R c/cuscinetto/ball bearing nut	Dx/Rh
T118.824.R	68	63	50	2÷30 (Art. T123/ER40)	Z091.002.R	Dx/Rh
T118.824.L	68	63	50	2÷30 (Art. T123/ER40)	Z091.002.L	Sx/Lh
T118.826.R	68	63	50	2÷30 (Art. T123/ER40)	Z091.102.R c/cuscinetto/ball bearing nut	Dx/Rh

## PORTAUTENSILI CONO HSK-40A / COLLET CHUCKS HSK-40A

ART. T118

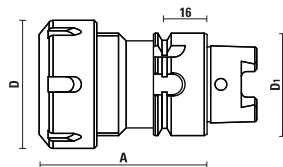

- L'attacco conico è costruito secondo la normativa DIN69893
- Viene fornito completo di ghiera (senza pinza)
- Ghiera DIN 6499
- La quota "A" è rilevata con l'utensile montato su nostra pinza DIN6499. Da notare che la quota "A" può subire variazioni in base al diametro dell'utensile in pinza.

- The hollow taper shank is produced according to DIN69893
- Supplied with nut (without collet)
- Threaded nut DIN 6499
- The "A" measure will be determined with clamped tool shanks by using our spring collet DIN6499. The "A" measure may be subject to variations depending on the diameter of the clamped tools.

Per macchine/for "Centauro"

Articolo/Item	Cono/Taper	A	D	D1	Pinze/Spring collets	Ghiera/Clamping nut	Rot.
T118.950.R	HSK-40A	65	50	40	∅ 2÷20 (Art. T119/ER32)	Z091.001.R	RH
T118.951.R <b>NEW</b>	HSK-40A	65	42	40	∅ 1÷16 (Art. T125/ER25)	Z091.103.R	RH

## PORTAUTENSILI CONO HSK-63F/COLLET CHUCKS HSK-63F

ART. T118

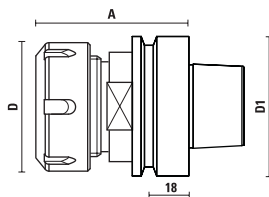

- Viene fornito completo di ghiera (senza pinza)
- Ghiera DIN 6499
- Ghiera DIN 6388 (EOC25)
- La quota "A" è rilevata con l'utensile montato su nostra pinza DIN6499 - DIN 6388 (EOC25).  
Da notare che la quota "A" può subire variazioni in base al diametro dell'utensile in pinza.
- L'attacco conico è costruito secondo la normativa DIN69893 ed è predisposto per l'alloggiamento del microchip "Balluff".
- Supplied with nut (without collet)
- Threaded nut DIN 6499
- Threaded nut DIN 6388 (EOC25)
- The "A" measure will be determined with clamped tool shanks by using our spring collet DIN6499 - DIN 6388/EOC25. The "A" measure may be subject to variations depending on the diameter of the clamped tools
- The hollow taper shank is produced according to DIN69893 for inserting the Balluff microchip.

Articolo/Item	Cono/Taper	A	D	D1	Pinze/Spring collets	Ghiera/Clamping nut	Rot.
T118.975.R	HSK-63 F	70	42	63	3÷16 (Art. T125/ER25)	Z091.103.R	Dx/Rh
T118.976.R	HSK-63 F	75	50	63	2÷20 (Art. T119/ER32)	Z091.001.R	Dx/Rh
T118.976.L	HSK-63 F	75	50	63	2÷20 (Art. T119/ER32)	Z091.001.L	Sx/Lh
T118.978.R	HSK-63 F	76	50	63	2÷20 (Art. T119/ER32)	Z091.101.R c/cuscinetto/ball bearing nut	Dx/Rh
T118.980.R	HSK-63 F	75	63	63	2÷30 (Art. T123/ER40)	Z091.002.R	Dx/Rh
T118.980.L	HSK-63 F	75	63	63	2÷30 (Art. T123/ER40)	Z091.002.L	Sx/Lh
T118.982.R	HSK-63 F	78	63	63	2÷30 (Art. T123/ER40)	Z091.102.R c/cuscinetto/ball bearing nut	Dx/Rh
T118.983.R	HSK-63 F	78	60	63	3÷26 (Art. T124/EOC25)	Z091.202.R	Dx/Rh
T118.984.R	HSK-63 F	78	60	63	3÷26 (Art. T124/EOC25)	Z091.203.R c/cuscinetto/ball bearing nut	Dx/Rh
T118.994.R	HSK-63 F	115	60	63	2÷26 (Art. T124/EOC25)	Z091.203.R c/cuscinetto/ball bearing nut	Dx/Rh

## PORTAUTENSILI CONO HSK-50F COLLET CHUCKS HSK-50F

ART. T118

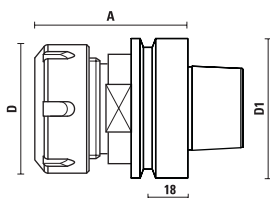

- Viene fornito completo di ghiera (senza pinza)
- Ghiera DIN 6499
- Ghiera DIN 6388 (EOC25)
- La quota "A" è rilevata con l'utensile montato su nostra pinza DIN6499. Da notare che la quota "A" può subire variazioni in base al diametro dell'utensile in pinza.
- L'attacco conico è costruito secondo la normativa DIN69893 ed è predisposto per l'alloggiamento del microchip "Balluff".
- Supplied with nut (without collet)
- Threaded nut DIN 6499
- Threaded nut DIN 6388 (EOC25)
- The "A" measure will be determined with clamped tool shanks by using our spring collet DIN6499. The "A" measure may be subject to variations depending on the diameter of the clamped tools.
- The hollow taper shank is produced according to DIN69893 for inserting the Balluff microchip.

Articolo/Item	Cono/Taper	A	D	D1	Pinze/Spring collets	Ghiera/Clamping nut	Rot.
T118.962.R	HSK-50F	60	42	50	2÷16 (Art. T125/ER25)	Z091.103.R	Dx/Rh
T118.966.R	HSK-50 F	73	50	50	2÷20 (Art. T119/ER32)	Z091.001.R	Dx/Rh
T118.968.R	HSK-50 F	76	50	50	2÷20 (Art. T119/ER32)	Z091.101.R c/cuscinetto/ball bearing nut	Dx/Rh
T118.970.R	HSK-50F	76	63	50	2÷30 (Art. T123/ER40)	Z091.002.R	Dx/Rh
T118.972.R	HSK-50F	78	63	50	2÷30 (Art. T123/ER40)	Z091.102.R c/cuscinetto ball bearing nut	Dx/Rh
T118.974.R	HSK-50 F	78	60	50	2÷26 (Art. T124/EOC25)	Z091.203.R	Dx/Rh

## VITE ANTIPOLVERE/DUST PLUG

ART. Z051

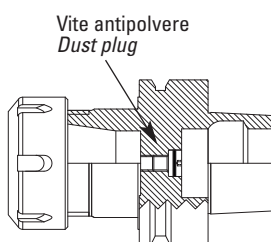
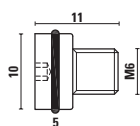

- Da utilizzare sui nostri coni HSK per evitare che la polvere contamini l'elettromandrino.
- Economica e facile da montare
- To be used with our HSK toolholders to avoid any contamination of dust into the electrosindle.
- Inexpensive and easy to use.

Articolo/Item	Descrizione/Description
Z051.070.N	M6x6

## PORTAUTENSILI CONO HSK FORMA "E" COLLET CHUCKS HSK "E"

ART. T118

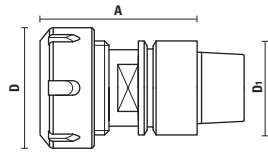

- Viene fornito completo di ghiera (senza pinza)
- Ghiera DIN 6499
- **Equilibratura G2,5 x 25.000 g/min**
- La quota "A" è rilevata con l'utensile montato su nostra pinza DIN6499. Da notare che la quota "A" può subire variazioni in base al diametro dell'utensile in pinza.
- L'attacco conico è costruito secondo la normativa DIN69893 ed è predisposto per l'alloggiamento del microchip "Balluff"
- *Supplied with nut (without collet)*
- *Threaded nut DIN 6499*
- **Balanced to 25.000 RPM at G 2,5**
- *The "A" measure will be determined with clamped tool shanks by using our spring collet DIN6499. The "A" measure may be subject to variations depending on the diameter of the clamped tools.*
- *The hollow taper shank is produced according to DIN69893 for inserting the Balluff microchip*

Articolo/Item	Cono/Taper	A	D	D1	Pinze/Spring collets	Ghiera/Clamping nut	Rot.
T118.990.R *1	HSK-25E	40	22	25	2÷10 (Art. T127/ER16)	Z091.405.R Mini	Dx/Rh
T118.991.R	HSK-32E	60	35	32	1÷13 (Art. T126/ER20)	Z091.104.R	Dx/Rh
T118.992.R *1	HSK-32E	60	42	32	2÷16 (Art. T125/ER25)	Z091.103.R	Dx/Rh
T118.993.R *2	HSK-40E	70	35	40	2÷16 (Art. T125/ER25)	Z091.403.R Mini	Dx/Rh
T118.997.R	HSK-50E	80	42	50	2÷16 (Art. T125/ER25)	Z091.103.R	Dx/Rh
T118.998.R	HSK-50E	100	50	50	2÷20 (Art. T119/ER32)	Z091.001.R	Dx/Rh

\* 1 Bilanciatura G2,5 x 40.000 g/min per macchine "Multicam"/Balanced to 40.000 RPM at G2,5 for "Multicam" machines

\* 2 Bilanciatura G2,5 x 34.000 g/min /Balanced to 34.000 RPM at G2,5

## PORTAUTENSILI CONO HSK-63E/COLLET CHUCKS HSK-63E

ART. T118

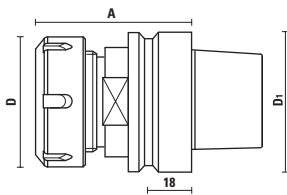

- Viene fornito completo di ghiera (senza pinza)
- Ghiera DIN 6499
- La quota "A" è rilevata con l'utensile montato su nostra pinza DIN6499. Da notare che la quota "A" può subire variazioni in base al diametro dell'utensile in pinza.
- L'attacco conico è costruito secondo la normativa DIN69893 ed è predisposto per l'alloggiamento del microchip "Balluff".
- *Supplied with nut (without collet)*
- *Threaded nut DIN 6499*
- *The "A" measure will be determined with clamped tool shanks by using our spring collet DIN6499. The "A" measure may be subject to variations depending on the diameter of the clamped tools.*
- *The hollow taper shank is produced according to DIN69893 for inserting the Balluff microchip.*

Articolo/Item	Cono/Taper	A	D	D1	Pinze/Spring collets	Ghiera/Clamping nut	Rot.
T118.985.R	HSK-63E	76	50	63	2÷20 (Art. T119/ER32)	Z091.001.R	Dx/Rh
T118.985.R100	HSK-63E	100	50	63	2÷20 (Art. T119/ER32)	Z091.001.R	Dx/Rh
T118.986.R	HSK-63E	76	50	63	2÷30 (Art. T134/ETS32)	Z091.301.R	Dx/Rh
T118.987.R	HSK-63E	76	63	63	2÷30 (Art. T123/ER40)	Z091.002.R	Dx/Rh
T118.988.R	HSK-63E	76	63	63	4÷25 (Art. T135/ETS40)	Z091.302.R	Dx/Rh

## TIRANTI PER CONI PORTAUTENSILI/RETAINING PAWLS FOR CONCENTRIC CHUCK

ART. T118

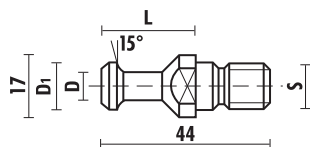

Articolo/Item	Tipo/Type	D1	D2	D	L	LT	S
T118.791.R	ISO 30	13	17	9	24	44	M12

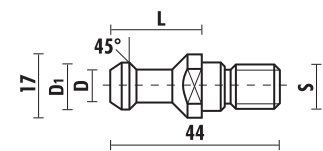

Articolo/Item	Tipo/Type	D1	D	L	S
T118.792.R	ISO 30	12,8	9	24	M12

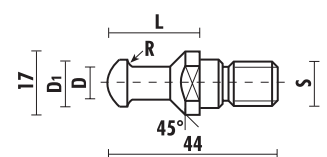

Articolo/Item	Tipo/Type	D1	D	L	R	S
T118.891.R	ISO 30	12	8	24	3,2	M12

## PORTAUTENSILI CONO HSK-63F ER16 - G 2,5 COLLET CHUCKS HSK-63F ER16 - G2.5 BALANCING

ART. TJ118

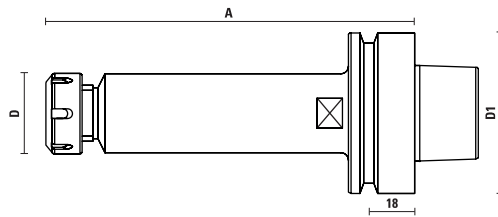

- **Equilibratura G2,5**
- Velocità di rotazione massima **36.000 giri/min**
- Viene fornito completo di ghiera standard
- Ghiera e chiave standard
- La quota "A" è rilevata con l'utensile montato su nostra pinza DIN6499. Da notare che la quota "A" può subire variazioni in base al diametro dell'utensile in pinza.

- **Balanced at G2.5**
- **Maximum speed rotation at 36.000 RPM**
- **Supplied with standard clamping nut**
- **Threaded nut and wrenches**
- *The "A" measure will be determined with clamped tool shanks by using our spring collet DIN6499. The "A" measure may be subject to variations depending on the diameter of the clamped tools.*

Articolo/Item	Cono/Taper	A	D	D1	Pinze/Spring collets	Ghiera/Clamping nut	Rot.
TJ118.900.R070	HSK-63F	70	32	63	Ø 2÷10 (Art. T127/ER16)	Z091.105.R	Dx/Rh
TJ118.900.R100	HSK-63F	100	32	63	Ø 2÷10 (Art. T127/ER16)	Z091.105.R	Dx/Rh
TJ118.900.R150	HSK-63F	150	32	63	Ø 2÷10 (Art. T127/ER16)	Z091.105.R	Dx/Rh

## PORTAUTENSILI CONO HSK-63F ER32 - G2,5 COLLET CHUCKS HSK-63F ER32 - G2.5 BALANCING

ART. TJ118

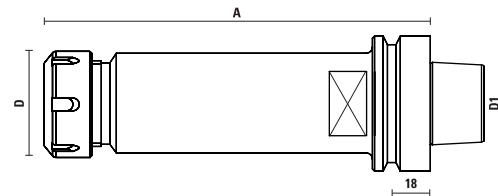

- **Equilibratura G2,5**
- Velocità di rotazione massima **36.000 giri/min**
- Viene fornito completo di ghiera standard
- Ghiera e chiave standard
- La quota "A" è rilevata con l'utensile montato su nostra pinza DIN6499. Da notare che la quota "A" può subire variazioni in base al diametro dell'utensile in pinza.

- **Balanced at G2.5**
- **Maximum speed rotation at 36.000 RPM**
- **Supplied with standard clamping nut**
- **Threaded nut and wrenches**
- *The "A" measure will be determined with clamped tool shanks by using our spring collet DIN6499. The "A" measure may be subject to variations depending on the diameter of the clamped tools.*

Articolo/Item	Cono/Taper	A	D	D1	Pinze/Spring collets	Ghiera/Clamping nut	Rot.
TJ118.976.R075	HSK-63F	75	50	63	Ø 2÷20 (Art. T119/ER32)	Z091.001.R	Dx/Rh
TJ118.976.R100	HSK-63F	100	50	63	Ø 2÷10 (Art. T119/ER32)	Z091.001.R	Dx/Rh
TJ118.976.R125	HSK-63F	125	50	63	Ø 2÷20 (Art. T119/ER32)	Z091.001.R	Dx/Rh
TJ118.976.R180	HSK-63F	180	50	63	Ø 2÷20 (Art. T119/ER32)	Z091.001.R	Dx/Rh

## GHIERE PER MANDRINI/COLLET NUTS

ART. Z091

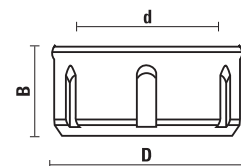

Art./Item	Cono/Taper	D	B	d	Rot.
Z091.001.R	DIN 6499 (ER 32)	50	23	M 40x1,5	Dx/Rh
Z091.001.L	DIN 6499 (ER 32)	50	23	M 40x1,5	Sx/Lh
Z091.002.R	DIN 6499 (ER 40)	63	25	M 50x1,5	Dx/Rh
Z091.002.L	DIN 6499 (ER 40)	63	25	M 50x1,5	Sx/Lh
Z091.103.R	DIN 6499 (ER 25)	42	20	M 32x1,5	Dx/Rh
Z091.104.R	DIN 6499 (ER 20)	35	19	M 25x1,5	Dx/Rh
Z091.105.R	DIN 6499 (ER 16)	32	17,5	M 22x1,5	Dx/Rh
Z091.202.R	DIN 6388 (EOC25)	60	30	M 48x2	Dx/Rh
Z091.301.R	ETS 32	50	23	M 40x1,5	Dx/Rh
Z091.302.R	ETS 40	63	25	M 50x1,5	Dx/Rh
Z091.403.R	ER 25 mini	35	20	M 30x1	Dx/Rh
Z091.404.R	ER 20 mini	28	19	M 24x1	Dx/Rh
Z091.405.R	ER 16 mini	22	18	M 19x1	Dx/Rh

## GHIERE PER MANDRINI CON CUSCINETTO COLLET NUTS WITH BALL BEARINGS

ART. Z091

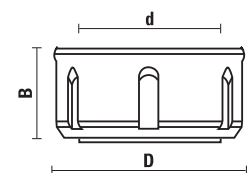

Consente la rotazione sia destra che sinistra  
*It can be used both for right-hand and left-hand rotation*

Art./Item	Tipo/Taper	D	B	d	Rot.
Z091.100.R	DIN 6499 (ER 25)	42	20	M 32x1,5	Dx-Sx/Rh-Lh
Z091.101.R	DIN 6499 (ER 32)	50	26	M 40x1,5	Dx-Sx/Rh-Lh
Z091.102.R	DIN 6499 (ER 40)	63	29	M 50x1,5	Dx-Sx/Rh-Lh
Z091.203.R	DIN 6388 (EOC25)	60	30	M 48x2	Dx-Sx/Rh-Lh



## GHIERA CONVOGLIATORE/DUST & CHIP EXTRACTION NUT

ART. T139

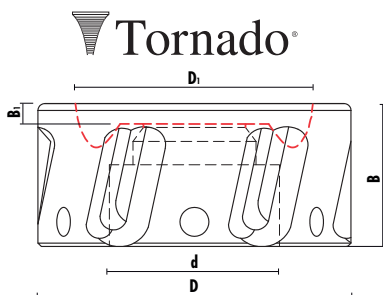

**ATTENZIONE:** utilizzare il Tornado solo quando la lavorazione assicura una fresata poco profonda e con trucioli molto piccoli.

**WARNING:** Use the Tornado nuts only when the machining process ensures shallow routing with very small chips.

- Costruito in lega leggera (alluminio) con uno speciale rivestimento specifico contro l'usura e la corrosione
- Appositamente studiato per migliorare l'aspirazione di polveri e trucioli dal piano di lavoro
- Trattamento di indurimento superficiale per evitarne l'usura ed aumentare la durata, per una migliore evacuazione del truciolo
- Distanza ottimale dal piano di lavoro è 2 mm. Lavora con efficacia fino a 10 mm
- Diametro più piccolo: (D=92 mm), per poter essere utilizzato su qualsiasi macchina/pantografo CNC
- **Adatto per tutti i tipi di cono (HSK, ISO, BT, ...)**
- Velocità di rotazione massima 20.000 RPM
- Bilanciatura G 2,5, peso 0,256 kg
- **Tool body in light alloy with a special surface coating against wear and corrosion for a maximum chips evacuation**
- **Optimal gap between Tornado® and material is 2 mm (0.078"). It works properly up to 10 mm (0.38")**
- **Smaller diameter: (92 mm) in order to be mounted on every CNC router/machining centre**
- **Suitable for every type of collet chuck (HSK, ISO, BT, ...)**
- **Maximum speed rotation at 20.000 RPM**
- **Balanced at G2,5, weight 0,256 kg**

Watch the Video on YouTube



Articolo/Item	Cono/Taper	D	D1	B	B1	d	Rot.
T139.501.RK	DIN6499 (ER32)	92	70	40	6	M 40x1,5	Dx/Rh
T139.502.RK	DIN6499 (ER40)	92	70	42	6	M 50x1,5	Dx/Rh
T139.503.RK	DIN6499 (ER25)	92	70	42	6	M 32x1,5	Dx/Rh
T139.522.RK	DIN6388 (EOC25)	92	70	42	6	M 48x2	Dx/Rh
T139.581.RK	DIN6499 (ER32)	80	64	42	6	M 40x1,5	Dx/Rh

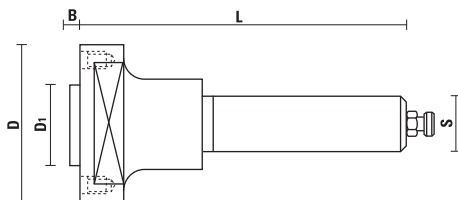

## ADATTATORE PER SEGHE CIRCOLARI ADAPTER FOR CIRCULAR SAWBLADES

ART. T128



- Nr. 4 fori a 90°
- Viene fornito completo di nr. 4 viti per il fissaggio della lama e vite di sicurezza
- **Si utilizza con nostro Art. XAH100 (Lamello®) e con seghe circolari di diametro fino a 200 mm**
- Gamma completa alla pagina 7.27 del nostro Catalogo 14.A

- Nr. 4 pin holes 90°
- Complete with nr. 4 screws to fix the sawblade
- **To be used with our item XAH100 (Lamello®) and with circular saw blades up to diameter 200 mm**
- Full range at page 7.27 of our Catalog 14.A

Articolo/Item	D	D1	B	S	L	Fori trasc./ Pin holes
T128.141.R	60	22	2,5	20x60	90	4/4/36
 Z051.018.R						
 Z051.506.R						
T128.140.R	60	30	2,5	20x60	90	4/6/48
T128.143.R	60	30	2,5	16x50	85	
T128.145.R	60	30	2,5	25x60	90	4/6/48



Z051.014.R



Z051.506.R

**ADATTATORE ISO 30 PER SEGHE CIRCOLARI**  
**ISO 30 ADAPTERS FOR CIRCULAR SAWBLADES**

ART. T128

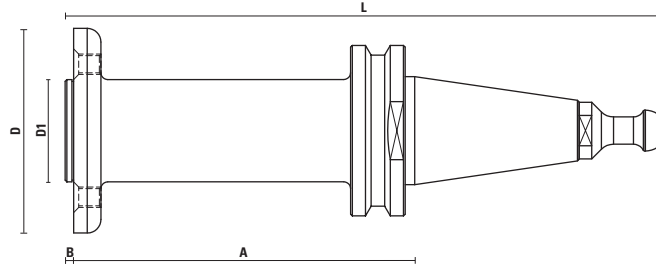

- Nr. 4 fori a 90°
- Viene fornito completo di nr. 4 viti per il fissaggio della lama e vite di sicurezza
- Da utilizzare con seghe circolari foro Ø 30 mm
- Si consiglia l'utilizzo con seghe circolari di diametro massimo di 200 mm
- Nr. 4 pin holes 90°
- Complete with nr. 4 screws to fix the sawblade
- For mounting saw blades with 30 mm bore
- For mounting saw blades with diameter max 200 mm

- Tirante/Retaining pawl T118.891.R per/for: Biesse

Articolo/Item	Cono/Taper	A	D	D1	D2	B	L
T128.150.R	ISO 30	100	60	30	50	2,5	174



Z051.014.R

**ADATTATORE PER SEGHE CIRCOLARI/ADAPTERS FOR CIRCULAR SAWBLADES**

ART. T128

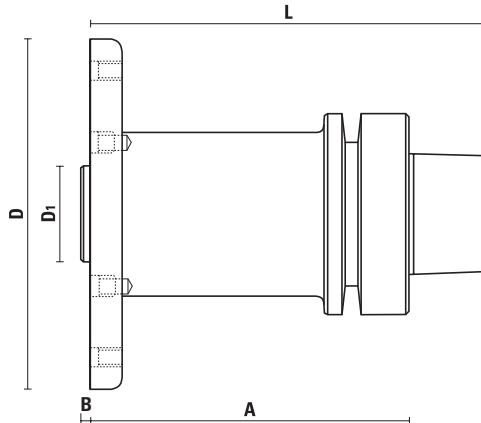

- Viene fornito di nr. 6 viti M6x10 per il corretto serraggio della lama con interasse 90 mm a 60°
- Da utilizzare con seghe circolari foro 30
- Si consiglia l'utilizzo con seghe circolari di diametro compreso tra 200 e 350 mm.
- Complete with nr. 6 screws (M6x10) for the proper assembly of sawblades with 60° at 90 mm distance
- For mounting sawblades with 30 mm bore
- For mounting sawblades with diameter between 200 and 350 mm.

Articolo/Item	Cono/Taper	A	D	D1	D2	B	L
T128.160.R	HSK-63F	40	110	30	63	2,5	65
T128.165.R	HSK-63F	100	110	30	63	2,5	125
T128.170.R	HSK-63E	40	110	30	63	2,5	72
T128.175.R	HSK-63E	100	110	30	63	2,5	132



Z051.014.R

**ESEMPIO DI MONTAGGIO/EXAMPLE OF USE:**

Adattatore HSK63 con lama inserita  
 HSK63 adapter with mounted Saw Blade

**OPTIONAL/ OPTIONS:**  
 Flangia di sicurezza (art. Z092.100.N) per montare lame fino a 400 mm di diametro cambiando le viti.  
 Security flange (item Z092.100.N) to secure sawblades with maximum diameter of 400 mm by changing screws.

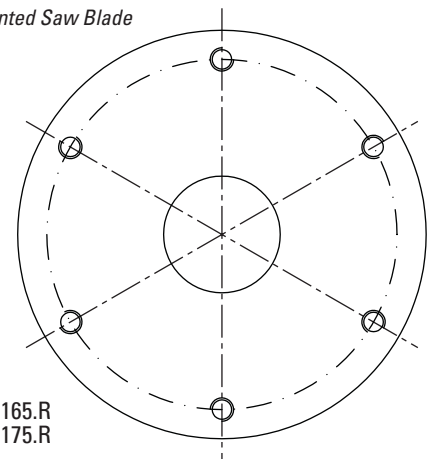
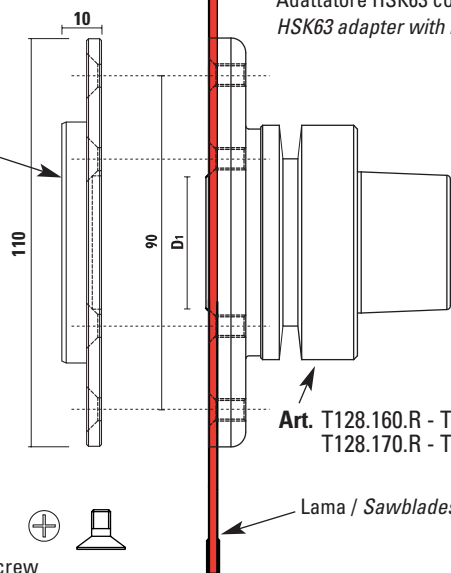

Art. T128.160.R - T128.165.R  
 T128.170.R - T128.175.R

Lama / Sawblades

**VITE/SCREW (ART. Z051.014.R)**  
 Vite M6x10 con testa svasata per il serraggio della lama  
 M6x10 countersunk flat head screw

## PORTAUTENSILI CONO HSK-63F PER CALETTAMENTO A CALDO

### SHRINK FIT CHUCKS HSK-63F

ART. T120



## HotBlock®

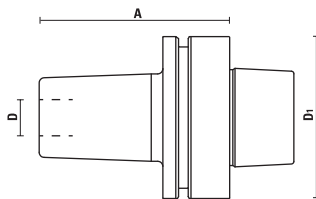

- Concentricità  $\leq 0,003$  mm
- Portautensili ad **alta precisione** grazie alla stretta termica
- Elevata stabilità e rigidità che li rende adatti per lavorazioni particolarmente gravose
- Per utensili in HW, HS e PKD
- Grado di **equilibratura G 2,5** x 24.000 RPM
- **Rotazione destra e sinistra**
- Alloggia utensili con gambo cilindrico tolleranza h6

- **Concentricity  $\leq 0,003$  mm**
- **High precision** tool holders guaranteed by thermally induced shrink fit
- **High rigidity and balance** for heavy CNC working
- For HS, HW and PCD cutting tool
- **Balanced to 24.000 RPM at G 2,5**
- **Right and left-hand rotation**
- Cutting tool shank must have tolerance h6 with cylindrical shank (no flats)

Articolo/Item	Cono/Taper	A	D1	D	Articolo/Item	Cono/Taper	A	D1	D
T120.564.N	HSK-63F	76	63	1/4" - (6,35 mm)	T120.627.N	HSK-63F	76	63	1/2" - (12,7 mm)
T120.580.N	HSK-63F	76	63	8	T120.660.N	HSK-63F	76	63	16
T120.595.N	HSK-63F	76	63	3/8" - (9,52 mm)	T120.695.N	HSK-63F	76	63	3/4" - (19,05 mm)
T120.600.N	HSK-63F	76	63	10	T120.700.N	HSK-63F	76	63	20
T120.620.N	HSK-63F	76	63	12	T120.750.N	HSK-63F	76	63	25

## PORTAUTENSILI CONO ISO 30 PER CALETTAMENTO A CALDO

### SHRINK FIT CHUCKS ISO 30

ART. T120



## HotBlock®

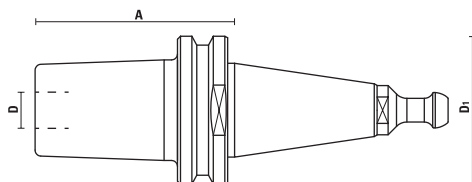

- Concentricità  $\leq 0,003$  mm
- Portautensili ad **alta precisione** grazie alla stretta termica
- Elevata stabilità e rigidità che li rende adatti per lavorazioni particolarmente gravose
- Per utensili in HW, HS e PKD
- Grado di **equilibratura G 2,5** x 24.000 RPM
- **Rotazione destra e sinistra**
- Alloggia utensili con gambo cilindrico tolleranza h6
- Corredato di certificato di equilibratura

- **Concentricity  $\leq 0,003$  mm**
- **High precision** tool holders guaranteed by thermally induced shrink fit
- **High rigidity and balance** for heavy CNC working
- For HS, HW and PCD cutting tool
- **Balanced to 24.000 RPM at G 2,5**
- **Right and left-hand rotation**
- Cutting tool shank must have tolerance h6 with cylindrical shank (no flats)
- Sold complete with certificate of balancing

- Tirante/Retaining pawl T118.891.R per macchine/for: **Biesse, Masterwood - Bulleri** (motori/for H.S.D.), **Hiteco** included

- Altri tiranti si possono montare su richiesta/Other Retaining pawl can be fitted on request

Articolo/Item	Cono/Taper	A	D1	D	Articolo/Item	Cono/Taper	A	D1	D
T120.320.N	ISO 30	76	50	12	T120.400.N	ISO 30	76	50	20
T120.360.N	ISO 30	76	50	16					

**HotBlock®:** i portautensili a calettamento sfruttano la dilatazione termica del cono, generata dalla stazione per calettamento (vedi Art. K.START.2), per poter inserire utensili in HW e HS. Il successivo raffreddamento effettuato tramite il modulo di raffreddamento ad aria (vedi Art. K.FG500) riporta la parte terminale del cono alle dimensioni originarie permettendo così una stretta stabile e sicura degli utensili con la massima precisione di concentricità ( $\leq 3$  micron). Questi speciali coni, creando un'elevata forza di serraggio attorno all'utensile, rendono il sistema estremamente stabile e valido per effettuare operazioni particolarmente gravose.

**HotBlock®:** high precision tool holders which ensure more precision having less coupling thanks to its special tight on the shank tool by thermal clamping. First, the collet tip is heated with the special shrink fit unit (see our article K.START.2), causing it to expand. The cutter shank is then inserted, and the collet is cooled to ambient temperature with the cooling machine (see our article K.FG500). This causes the collet to contract precisely around the cutter shank with a special concentricity less than 3 micron, therefore the highest precision and stability for high performance.

## STAZIONE PER CALETTAMENTO

### SHRINK FIT UNIT

ART. K.START.2



- **Tempo di calettamento da 2 a 7 secondi**
- Provvisto di anelli induttore ( $\varnothing 6 - \varnothing 12$ ) + ( $\varnothing 14 - \varnothing 20$ ) e di supporto per coni HSK63F
- Riscaldamento localizzato del porta utensile, senza alterazione dell'utensile e del porta utensile
- **Autoregolazione della potenza di riscaldamento** grazie a un microprocessore interno
- **Induttore reversibile a 180°** senza smontaggio
- Alimentazione elettrica 3x380/480V - 16A 50/60 Hz - 14 kW
- Dimensioni L= 255 mm - P= 490 mm - H= 755 mm
- Peso (senza optional) 20 kg
- **Heating time from 2 to 7 seconds**
- Provided with inductor stop rings ( $\varnothing 6$  to  $\varnothing 12$ ) + ( $\varnothing 14$  to  $\varnothing 20$ ) and chuck holder for HSK63F
- Heating located on the tool holder, no deterioration of the tool and tool holder
- **Self-regulated power** thanks to a microprocessor depending on parameters detected
- **Inductor rotates 180°** without disassembling
- Power supply 3x380/480V - 16A 50/60 Hz - 14 kW
- Dimensions: L= 255 mm - D= 490 mm - H= 755 mm
- Weight (options excluded) 20 kgs

## MODULO DI RAFFREDDAMENTO AD ARIA

### COOLING UNIT WITH AIR FLOW

ART. K.FG500



- Per il raffreddamento di coni porta utensili a calettare
- **Tempi di raffreddamento da 1 minuto e 30 a 3 minuti**
- Provvisto di anelli di raffreddamento ( $\varnothing 6 - \varnothing 12$ ) + ( $\varnothing 14 - \varnothing 20$ ) e di supporto per coni HSK63F
- Alimentazione pneumatica: 4-6 bar
- Dimensioni L= 220 mm - P= 190 mm - H= 615 mm
- Peso 5 kg
- Air cooling unit for shrink fit chucks
- **Cooling time from 1,30 minute to 3 minutes**
- Provided with cooling stop rings ( $\varnothing 6$  to  $\varnothing 12$ ) + ( $\varnothing 14$  to  $\varnothing 20$ ) and chuck holder for HSK63F
- Compressed air supply: 4-6 bars
- Dimensions: L= 220 mm - D= 190 mm - H= 615 mm
- Weight: 5 kgs

Articolo/Item

K.START.2

Articolo/Item

K.FG500

**NB:** Questi articoli non sono offerti in Germania perchè l'azienda produttrice "Elco" lo distribuisce attraverso rivenditori esclusivi.

**NB:** This items cannot be sold in Germany due to commercial agreements between the producer (Elco) and their authorised dealers in these markets.

## PROLUNGHE CILINDRICHE PER CONI A CALETTAMENTO A CALDO L=150 SHRINK FIT CHUCK EXTENSIONS L=150

ART. T120



- Adatte per lavorazioni profonde e difficili da raggiungere
- Si raccomanda l'uso su coni a calettamento a caldo (vedi ns. Art. T120) o su coni hydro
- Risultati ottimali su utensili HW e HS con gambo in tolleranza h6
- **Complete di vite di regolazione**
- Suitable for **working deep and hard to reach surfaces**
- To be used with heat shrink fit chucks (our item T120) or hydro chuck
- Best results when clamping HW or HS tools with h6 tool shank
- **With adjusting screw for length adjustment**

Articolo/Item	D	d	L	L1	Vite/Screw
T120.012.03	12	3	150	12	M5
T120.012.04	12	4	150	16	M5
T120.016.04	16	4	150	16	M5
T120.016.06	16	6	150	26	M5
T120.020.06	20	6	150	26	M5
T120.020.08	20	8	150	26	M6
T120.020.10	20	10	150	32	M6
T120.020.12	20	12	150	37	M10
T120.025.08	25	8	150	26	M6
T120.025.10	25	10	150	32	M6
T120.025.12	25	12	150	37	M10
T120.025.16	25	16	150	40	M10

## PROLUNGHE CILINDRICHE PORTAPINZE STRAIGHT SHANK TOOL EXTENSION

ART. T121

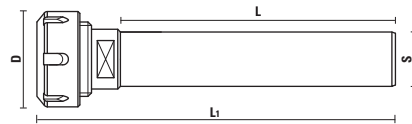

- Da utilizzare su cono portapinza
- Adatte per lavorazioni profonde e difficili da raggiungere
- To be used on ER tool holders
- Suitable for **working deep and hard to reach surfaces**

Articolo/Item	D	Pinze/Spring collets	Ghiera/Clamping nut	S	L	L1	Rot.
T121.016.120.080	22	2÷10 (Art. T127/ER16)	Z091.405.R Mini	12	80	118	Dx/Rh
T121.016.160.100	22	2÷10 (Art. T127/ER16)	Z091.405.R Mini	16	100	138	Dx/Rh
T121.016.200.100	22	2÷10 (Art. T127/ER16)	Z091.405.R Mini	20	100	131	Dx/Rh
T121.016.200.160	22	2÷10 (Art. T127/ER16)	Z091.405.R Mini	20	160	191	Dx/Rh
T121.016.200.200	22	2÷10 (Art. T127/ER16)	Z091.405.R Mini	20	200	231	Dx/Rh
T121.020.160.100	28	2÷13 (Art. T126/ER20)	Z091.404.R Mini	16	100	142	Dx/Rh
T121.020.160.160	28	2÷13 (Art. T126/ER20)	Z091.404.R Mini	16	160	202	Dx/Rh
T121.020.200.100	28	2÷13 (Art. T126/ER20)	Z091.404.R Mini	20	100	137	Dx/Rh
T121.020.200.160	28	2÷13 (Art. T126/ER20)	Z091.404.R Mini	20	160	197	Dx/Rh
T121.020.250.160	28	2÷13 (Art. T126/ER20)	Z091.404.R Mini	25	160	188	Dx/Rh
T121.020.250.240	28	2÷13 (Art. T126/ER20)	Z091.404.R Mini	25	240	282	Dx/Rh
T121.025.200.060	35	3÷16 (Art. T125/ER25)	Z091.403.R Mini	20	60	106	Dx/Rh
T121.025.200.100	35	3÷16 (Art. T125/ER25)	Z091.403.R Mini	20	100	146	Dx/Rh
T121.025.200.160	35	3÷16 (Art. T125/ER25)	Z091.403.R Mini	20	160	206	Dx/Rh
T121.025.250.100	42	3÷16 (Art. T125/ER25)	Z091.103.R	25	100	140	Dx/Rh
T121.025.250.160	42	3÷16 (Art. T125/ER25)	Z091.103.R	25	160	200	Dx/Rh

### Esempio d'utilizzo/Example of use:

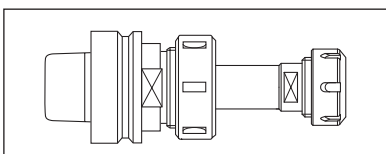

- Per un corretto utilizzo, l'attacco cilindrico della prolunga deve essere inserito per tutta la lunghezza della pinza.
- È importante stringere la ghiera del cono portapinza utilizzando una chiave dinamometrica assicurando la corretta forza di tenuta.
- A prolunga montata sul cono portapinza, il grado di equilibratura non viene garantito.
- For a proper use and maximum holding power, fill the collet all the way with the extension shank;
- It is very important to tighten the collet nut of tool holder to recommended torque using a torque wrench;
- When the extension is mounted, balancing grade is not guaranteed.

## CONI ACCIAIO INOX/STAINLESS STEEL COLLET CHUCKS

### Informazioni utili/Useful information:

La costruzione in **acciaio INOX integrale** senza ulteriori riporti rende il cono più resistente e duraturo. La pallinatura CNC conferisce ai portautensili **una ancor superiore inossidabilità e un gradevole aspetto estetico**. I portautensili costruiti in **acciaio inox integrale** a differenza dei coni con rivestimenti superficiali non hanno il problema della scheggiatura o sfogliatura del rivestimento e garantiscono maggior inossidabilità e costanza di forma a tutto vantaggio delle lavorazioni e della longevità dell'elettromandrino.

- Solid stainless steel collet chucks are more resistant and have a longer life span;
- A special treatment guarantees an excellent resistance to corrosion and an aesthetic pleasing;
- No problems of peeling compared to coated chrome chucks of our competitors;
- Better working performances and longer life of the electrospindles;
- Produced in stainless steel AISI 420;
- Needed when working with coolant: machines for marble, glass, aluminium working and others;
- Highly recommended when processing resinoid wood and composite materials;
- Suggested when working in "humid" environment; - Extremely low maintenance costs, easy to clean.



## PORTAUTENSILI INOX CONO ISO 30/COLLET CHUCKS ISO 30 INOX

ART. T118

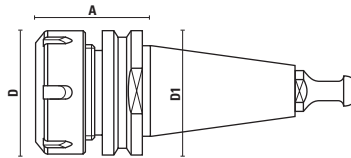

- La quota "A" è rilevata con l'utensile montato su nostra pinza DIN6499. Da notare che la quota "A" può subire variazioni in base al diametro dell'utensile in pinza.
- The "A" measure will be determined with clamped tool shanks by using our spring collet DIN6499. The "A" measure may be subject to variations depending on the diameter of the clamped tools.

- Costruiti in acciaio inossidabile AISI 420
- Con trattamento di micropallinatura;
- Viene fornito completo di ghiera e tirante (senza pinza);
- **Indispensabili con l'utilizzo di lubrificanti** (macchine per la lavorazione del marmo, vetro, alluminio e altre);
- Particolarmente indicati nelle **lavorazioni con esalazioni di vapore** che li possono fortemente intaccare, ad esempio per la lavorazione di legni resinoidi e materiali composti, o nelle **lavorazioni in ambienti umidi**;
- Costi di manutenzione pressochè nulli, massima igiene e semplicità di pulitura;
- Per lavori in presenza di lubrificante, utilizzare **pinze a tenuta stagna** a pag. 14
- **Produced in stainless steel AISI 420**
- Special micro-shot peening treatment;
- Supplied with nut (without collet) and retaining pawl;
- Needed when working with coolant: machines for marble, glass, aluminium working and others;
- Highly recommended when processing resinoid wood and composite materials;
- Suggested when working in "humid" environment;
- Extremely low maintenance costs, easy to clean;
- When used with coolant our water-tight spring collets are suggested (see page 14)

- Tirante/Retaining pawl T118.891.R per macchine/for: **Biesse** (dopo il/after 09/09/92), **Masterwood - Bulleri** (motori/motor H.S.D.)

Articolo/Item	A	D	D1	Pinze/Spring collets	Ghiera/Clamping nut	Rot.
T118.800.RAI	50	50	50	2÷20 (Art. T119/ER32)	Z091.001.R	Dx/Rh
T118.802.RAI	50	50	50	2÷20 (Art. T119/ER32)	Z091.101.R c/cuscinetto/ball bearing nut	Dx/Rh
T118.830.RAI	55	63	50	2÷30 (Art. T123/ER40)	Z091.002.R	Dx/Rh
T118.832.RAI	55	63	50	2÷30 (Art. T123/ER40)	Z091.102.R c/cuscinetto/ball bearing nut	Dx/Rh

## PORTAUTENSILI INOX CONO HSK63F/COLLET CHUCKS HSK63F INOX

ART. T118

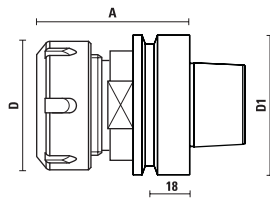

- La quota "A" è rilevata con l'utensile montato su nostra pinza DIN6499. Da notare che la quota "A" può subire variazioni in base al diametro dell'utensile in pinza.
- The "A" measure will be determined with clamped tool shanks by using our spring collet DIN6499. The "A" measure may be subject to variations depending on the diameter of the clamped tools.

- Costruiti in acciaio inossidabile AISI 420
- Con trattamento di micropallinatura;
- Viene fornito completo di ghiera e tirante (senza pinza);
- **Indispensabili con l'utilizzo di lubrificanti** (macchine per la lavorazione del marmo, vetro, alluminio e altre);
- Particolarmente indicati nelle **lavorazioni con esalazioni di vapore** che li possono fortemente intaccare, ad esempio per la lavorazione di legni resinoidi e materiali composti, o nelle **lavorazioni in ambienti umidi**;
- Costi di manutenzione pressochè nulli, massima igiene e semplicità di pulitura;
- Per lavori in presenza di lubrificante, utilizzare **pinze a tenuta stagna** a pag. 14
- **Produced in stainless steel AISI 420**
- Special micro-shot peening treatment;
- Supplied with nut (without collet) and retaining pawl;
- Needed when working with coolant: machines for marble, glass, aluminium working and others;
- Highly recommended when processing resinoid wood and composite materials;
- Suggested when working in "humid" environment;
- Extremely low maintenance costs, easy to clean;
- When used with coolant our water-tight spring collets are suggested (see page 14)

Articolo/Item	A	D	D1	Pinze/Spring collets	Ghiera/Clamping nut	Rot.
T118.976.RAI	74	50	63	2÷20 (Art. T119/ER32)	Z091.001.R	Dx/Rh
T118.978.RAI	74	50	63	2÷20 (Art. T119/ER32)	Z091.101.R c/cuscinetto/ball bearing nut	Dx/Rh

## MASCHIATORI ISO 30 A CAMBIO RAPIDO QUICK CHANGE ISO 30 TAPPING CHUCK

ART. UT118

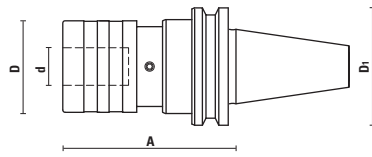

- Per eseguire filetti nella lavorazione dell' alluminio
- Mandrino a **compensazione assiale**
- Utilizzare con boccole portamaschi con diametro esterno D=19 mm DIN 352, DIN 371, DIN 376
- **Viene fornito senza tirante** (vedi pagina 5/on page 5)
- Adatti per l'utilizzo su centri di lavoro CNC
- For making threads in aluminium machining
- With **axial compensation**
- To be used with bushes for tapping with outer diameter D=19 mm DIN 352, DIN 371, DIN 376
- **Supplied without pull stud**
- For tapping operation on CNC machines

Articolo/Item	Cono/Taper	A	d	D	D1
UT118.080.N	ISO 30	74	19	39	50

## MASCHIATORI HSK63F A CAMBIO RAPIDO QUICK CHANGE HSK63F TAPPING CHUCK

ART. UT118

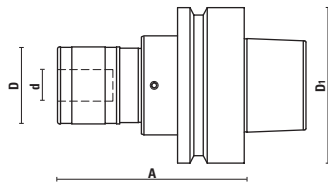

- Per eseguire filetti nella lavorazione dell' alluminio
- Mandrino a **compensazione assiale**
- Utilizzare con boccole portamaschi con diametro esterno D=19 mm DIN 352, DIN 371, DIN 376
- Adatti per l'utilizzo su centri di lavoro CNC
- For making threads in aluminium machining
- With **axial compensation**
- To be used with bushes for tapping with outer diameter D=19 mm DIN 352, DIN 371, DIN 376
- For tapping operation on CNC machines

Articolo/Item	Cono/Taper	A	d	D	D1
UT118.090.N	HSK63F	81	19	39	63

## BUSSOLE PORTAMASCHI A CAMBIO RAPIDO DIN 371 QUICK CHANGE BUSHES FOR TAPPING (DIN 371)

ART. UT100

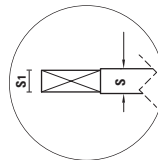
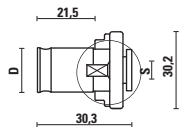

Attacco utensile maschiatore  
Thread tap shank with square

- Ideale per fori passanti
- **Alta precisione**, adatta per la lavorazione dell'alluminio
- Per montare maschiatori metrici
- Suitable for tapping of through holes
- **High precision**, suitable for processing aluminium
- For mounting taps ("M" series)

Articolo/Item	Filetto maschiatore/Thread	D	S= ØAttacco/Shank	S1= □Quadro/Square	Rot.
UT100.030.N	M3	19	3,5	2,7	Dx-SX/Rh-Lh
UT100.035.N	M3,5	19	4	3,15	Dx-SX/Rh-Lh
UT100.040.N	M4	19	4,5	3,4	Dx-SX/Rh-Lh
UT100.050.N	M5	19	6	4,9	Dx-SX/Rh-Lh
UT100.060.N	M6	19	6	4,9	Dx-SX/Rh-Lh
UT100.080.N	M8	19	8	6,2	Dx-SX/Rh-Lh
UT100.100.N	M10	19	10	8	Dx-SX/Rh-Lh
UT100.120.N	M12	19	9	7	Dx-SX/Rh-Lh

## BUSSOLE PORTAMASCHI A CAMBIO RAPIDO DIN 371 CON FRIZIONE QUICK CHANGE BUSHES FOR TAPPING (DIN 371) WITH SAFETY CLUTCH

ART. UT105

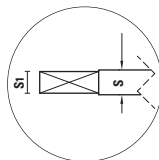
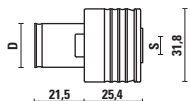

Attacco utensile maschiatore  
Thread tap shank with square

- Ideale per fori ciechi
- **Alta precisione**, adatta per la lavorazione dell'alluminio
- Per montare maschiatori metrici e prevenire la loro rottura grazie alla speciale frizione
- Suitable for tapping of blind holes
- **High precision**, suitable for processing aluminium
- For mounting taps and prevents their breakage due to the safety clutch
- For mounting taps ("M" series)

Articolo/Item	Filetto maschiatore/Thread	D	S= ØAttacco/Shank	S1= □Quadro/Square	Rot.
UT105.030.N	M3	19	3,5	2,7	Dx-SX/Rh-Lh
UT105.035.N	M3,5	19	4	3,15	Dx-SX/Rh-Lh
UT105.040.N	M4	19	4,5	3,4	Dx-SX/Rh-Lh
UT105.050.N	M5	19	6	4,9	Dx-SX/Rh-Lh
UT105.060.N	M6	19	6	4,9	Dx-SX/Rh-Lh
UT105.080.N	M8	19	8	6,2	Dx-SX/Rh-Lh
UT105.100.N	M10	19	10	8	Dx-SX/Rh-Lh
UT105.120.N	M12	19	9	7	Dx-SX/Rh-Lh

**Pinze ER - DIN 6499 Alta Precisione** costruite in acciaio per molle, vengono rettificate sia internamente che esternamente per la massima precisione. Le pinze **Klein** permettono di ridurre considerevolmente le vibrazioni dell'utensile e del motore durante la lavorazione, assicurando una vita maggiore all'utensile e all'elettromandrino. Usando le pinze insieme ai coni **Klein** raggiungerete un livello di **precisione=0,01** (0.0004" T.I.R.) e di affidabilità ottimale.

**Pinze ER - DIN 6499 Ultra Precise** sono consigliate per effettuare lavorazioni molto accurate e con elevato numero di giri su e centro di lavoro CNC. Grazie alla loro tolleranza di concentricità entro 0.005 mm (5 micron), sono in grado di garantire una maggiore precisione di accoppiamento con l'utensile e di ridurre al minimo lo squilibrio con il mandrino porta utensile.

**Spring collet ER - DIN 6499 Standard High Precision** they are built in spring steel and grounded both internally and externally for best accuracy and precision. **Klein** high precision spring collets allow to reduce vibrations on tools and motors during routing operations, ensuring a longer life of the tool and electrospindles. Using these spring collets on our high quality tool holders will give you the very best tool performance. **Precision=0,01** (0.0004" T.I.R.)

**ER spring collets - DIN6499 Ultra Precision** **Klein ULTRA PRECISION** collets are recommended for very accurate and high speed machining on CNC machining centers and router machines. Thanks to their concentricity tolerance within 0,005mm/0.0002" (runout of 5 micron), they are able to guarantee a higher precision of coupling with the tool and to minimize the unbalance with the tool holder.

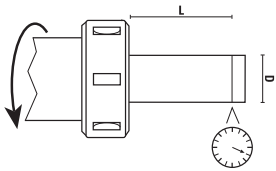

		<b>NEW Klein</b>		
D	L	Precisione Concorrenza Standard Competitor	Alta Precisione Standard Standard High Precision	Ultra Precisa Ultra Precision
Ø3 - Ø4 - Ø5	16	0,015	> 0,010	≅ 0,005
Ø6 ÷ Ø9,5	25	0,015	> 0,010	≅ 0,005
Ø10 ÷ Ø17	40	0,020	> 0,010	≅ 0,005
Ø18 ÷ Ø26	50	0,020	> 0,010	≅ 0,005

**PINZE ER 32 - DIN 6499**  
**SPRING COLLETS ER 32 - DIN 6499**  
ART. T119

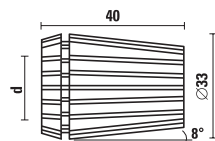

Precisione/Precision= 0,01

Articolo/Item	d	Articolo/Item	d
T119.016.N	1,59 (1/16")	T119.100.N	10 - 9
T119.020.N	2 - 1	T119.110.N	11 - 10
T119.030.N	3 - 2	T119.120.N	12 - 11
T119.032.N	3,2 (1/8")	T119.127.N	12,7 (1/2")
T119.040.N	4 - 3	T119.130.N	13 - 12
T119.048.N	4,8 (3/16")	T119.140.N	14 - 13
T119.050.N	5 - 4	T119.150.N	15 - 14
T119.060.N	6 - 5	T119.159.N	15,9 (5/8")
T119.064.N	6,4 (1/4")	T119.160.N	16 - 15
T119.070.N	7 - 6	T119.170.N	17 - 16
T119.079.N	7,9 (5/16")	T119.180.N	18 - 17
T119.080.N	8 - 7	T119.190.N	19 - 18
T119.090.N	9 - 8	T119.191.N	19,1 (3/4")
T119.095.N	9,5 (3/8")	T119.200.N	20 - 19

**SET DI PINZE ER32 - DIN 6499**  
**SPRING COLLET SET ER 32 - DIN 6499**  
ART. X119



- Set composto da 18 pinze
- Base di legno in pratica scatola di cartone.
- Complete with 18 pcs
- In carton Box

Articolo/Item	Diametri/Diameters:
X119.118.N	Ø3 - Ø4 - Ø5 - Ø6 - Ø7 - Ø8
	Ø9 - Ø10 - Ø11 - Ø12 - Ø13 - Ø14
	Ø15 - Ø16 - Ø17 - Ø18 - Ø19 - Ø20

**PINZE ER 40 - DIN 6499**  
**SPRING COLLETS ER 40 - DIN 6499**  
ART. T123

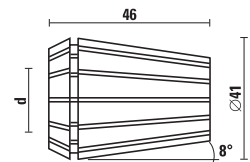
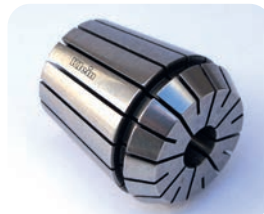

Precisione/Precision= 0,01

Articolo/Item	d	Articolo/Item	d
T123.030.N	3 - 2	T123.140.N	14 - 13
T123.032.N	3,2 (1/8")	T123.150.N	15 - 14
T123.040.N	4 - 3	T123.159.N	15,9 (5/8")
T123.048.N	4,8 (3/16")	T123.160.N	16 - 15
T123.050.N	5 - 4	T123.170.N	17 - 16
T123.060.N	6 - 5	T123.180.N	18 - 17
T123.064.N	6,4 (1/4")	T123.190.N	19 - 18
T123.070.N	7 - 6	T123.191.N	19,1 (3/4")
T123.079.N	7,9 (5/16")	T123.200.N	20 - 19
T123.080.N	8 - 7	T123.210.N	21 - 20
T123.090.N	9 - 8	T123.220.N	22 - 21
T123.095.N	9,5 (3/8")	T123.230.N	23 - 22
T123.100.N	10 - 9	T123.240.N	24 - 23
T123.110.N	11 - 10	T123.250.N	25 - 24
T123.120.N	12 - 11	T123.254.N	25,4 (1")
T123.127.N	12,7 (1/2")	T123.260.N	26 - 25
T123.130.N	13 - 12	T123.300.N	30 - 29

**SET DI PINZE ER40 - DIN 6499**  
**SPRING COLLET SET ER 40 - DIN 6499**  
ART. X123



- Set composto da 23 pinze
- Base di legno in pratica scatola di cartone.
- Complete with 23 pcs
- In carton Box

Articolo/Item	Diametri/Diameters:
X123.023.N	Ø3 - Ø4 - Ø5 - Ø6 - Ø7 - Ø8
	Ø9 - Ø10 - Ø11 - Ø12 - Ø13 - Ø14
	Ø15 - Ø16 - Ø17 - Ø18 - Ø19 - Ø20
	Ø21 - Ø22 - Ø23 - Ø24 - Ø25

## PINZE ER 25 - DIN 6499 SPRING COLLETS ER 25 - DIN 6499

ART. T125

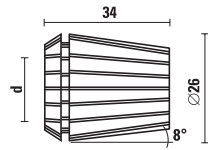

Precisione/Precision= 0,01

Articolo/Item	d
T125.016.N	1,59 (1/16")
T125.020.N	2 - 1
T125.030.N	3 - 2
T125.032.N	3,2 (1/8")
T125.040.N	4 - 3
T125.048.N	4,8 (3/16")
T125.050.N	5 - 4
T125.060.N	6 - 5
T125.064.N	6,4 (1/4")
T125.070.N	7 - 6
T125.079.N	7,9 (5/16")
T125.080.N	8 - 7
T125.090.N	9 - 8
T125.095.N	9,5 (3/8")
T125.100.N	10 - 9
T125.110.N	11 - 10
T125.120.N	12 - 11
T125.127.N	12,7 (1/2")
T125.130.N	13 - 12
T125.140.N	14 - 13
T125.150.N	15 - 14
T125.159.N	15,9 (5/8")
T125.160.N	16 - 15

## PINZE ER 20 - DIN 6499 SPRING COLLETS ER 20 - DIN 6499

ART. T126

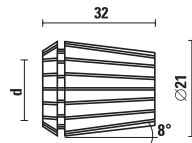

Precisione/Precision= 0,01

Articolo/Item	d
T126.016.N	1,59 (1/16")
T126.030.N	3 - 2
T126.032.N	3,2 (1/8")
T126.040.N	4 - 3
T126.050.N	5 - 4
T126.060.N	6 - 5
T126.064.N	6,4 (1/4")
T126.070.N	7 - 6
T126.080.N	8 - 7
T126.090.N	9 - 8
T126.095.N	9,5 (3/8")
T126.100.N	10 - 9
T126.110.N	11 - 10
T126.120.N	12 - 11
T126.127.N	12,7 (1/2")
T126.130.N	13 - 12

## PINZE ER 16 - DIN 6499 SPRING COLLETS ER 16 - DIN 6499

ART. T127

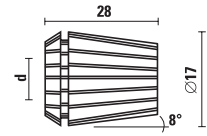

Precisione/Precision= 0,01

Articolo/Item	d
T127.016.N	1,59 (1/16")
T127.020.N	2 - 1
T127.030.N	3 - 2
T127.032.N	3,2 (1/8")
T127.040.N	4 - 3
T127.050.N	5 - 4
T127.060.N	6 - 5
T127.064.N	6,4 (1/4")
T127.070.N	7 - 6
T127.080.N	8 - 7
T127.090.N	9 - 8
T127.095.N	9,5 (3/8")
T127.100.N	10 - 9

## PINZE ER 11 - DIN 6499 SPRING COLLETS ER 11 - DIN 6499

ART. T129

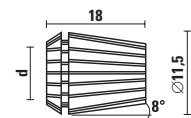

Precisione/Precision= 0,01

Articolo/Item	d
T129.010.N	1-0,5
T129.015.N	1,5-1
T129.020.N	2-1,5
T129.025.N	2,5-2
T129.030.N	3-2,5
T129.032.N	3,2 (1/8")
T129.035.N	3,5-3
T129.040.N	4-3,5
T129.045.N	4,5-4
T129.048.N	4,8 (3/16")
T129.050.N	5-4,5
T129.055.N	5,5-5
T129.060.N	6-5,5
T129.064.N	6,4 (1/4")
T129.065.N	6,5-6
T129.070.N	7-6,5



## PINZE ER 32 - DIN 6499 A TENUTA STAGNA WATER-TIGHT SPRING COLLETS ER 32 - DIN 6499

ART. T119

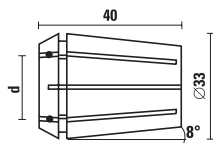

- Precisione= 0,01
- Particolarmente indicate nelle lavorazioni con presenza di lubrificanti
- Adatte per lavorare alluminio, marmo, vetro etc...
- Da non utilizzare con le nostre ghiera Standard Art. Z091
- Precision= 0,01
- Highly recommended when working with lubricant
- Indicated for working aluminium, marble, glass and others
- Do not use with our collet nuts Art. Z091

Articolo/Item	d	Articolo/Item	d
T119.020.NTS	2 - 1	T119.120.NTS	12 - 11
T119.030.NTS	3 - 2	T119.130.NTS	13 - 12
T119.040.NTS	4 - 3	T119.140.NTS	14 - 13
T119.050.NTS	5 - 4	T119.150.NTS	15 - 14
T119.060.NTS	6 - 5	T119.160.NTS	16 - 15
T119.070.NTS	7 - 6	T119.170.NTS	17 - 16
T119.080.NTS	8 - 7	T119.180.NTS	18 - 17
T119.090.NTS	9 - 8	T119.190.NTS	19 - 18
T119.100.NTS	10 - 9	T119.200.NTS	20 - 19
T119.110.NTS	11 - 10		

## CHIAVI A SETTORE/WRENCHES

ART. Z052

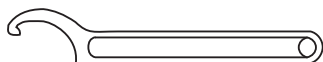

Articolo/Item	Descrizione/Description
Z052.310.N	chiave/wrench 58/62 per/for DIN6388/EOC25

## CHIAVI PER GHIERE TIPO STANDARD WRENCHES FOR COLLET NUT "STANDARD"

ART. Z052

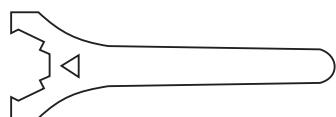

Articolo/Item	Descrizione/Description
Z052.401.N	per ghiera/for collet nut ER 32 standard
Z052.402.N	per ghiera/for collet nut ER 40 standard
Z052.404.N	per ghiera/for collet nut ER 20 standard
Z052.407.N	per ghiera/for collet nut ER 25 standard
Z052.409.N	per ghiera/for collet nut ER 16 standard

## CHIAVI DINAMOMETRICHE/TORQUE WRENCHES

Durante il montaggio dell'utensile è fondamentale riuscire ad ottenere un serraggio corretto. Una stretta insufficiente può causare l'uscita dell'utensile dalla sede durante la lavorazione, al contrario una eccessiva stretta rischia di rovinare il filetto del cono portapinza, la pinza e l'utensile. La chiave dinamometrica è in grado di segnalare il raggiungimento del valore di coppia impostato (Nm) e di garantire l'omogeneità del carico di stretta.

While setting a tool it is extremely important to tighten it appropriately. If not effectively tight indeed a cutting tool could slide away from the tool holder during the working process. On the other side, an excessive tightening can cause damages to the tool holder or spring collet or the tool itself. The wrench indicates when the torque (Nm) is reached according to the value in the corresponding table.

## CHIAVI DINAMOMETRICHE PER GHIERE "MINI" TORQUE WRENCHES FOR "MINI" NUTS

ART. Z052

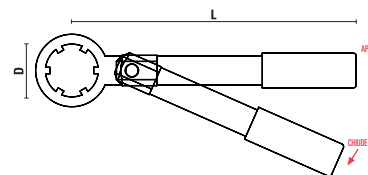

Articolo/Item	D	L	Nm	Ghiera/Clamping nut
Z052.702.N	22	175	28	ER16 Mini
Z052.704.N	35	185	40	ER25 Mini

## CHIAVI DINAMOMETRICHE PER GHIERE "STANDARD" TORQUE WRENCHES FOR "STANDARD" NUTS

ART. Z052

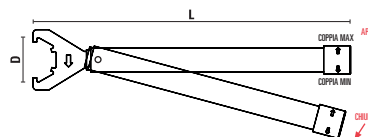

Dis. ① Quando si stringono pinze con scarico interno ruotare il pomello in **senso antiorario**, impostando la **COPPIA MIN**. Collets as per drawing n. 1 must be tightened by setting the minimum torque value and rotating the handle counterclockwise.

Dis. ② Quando si stringono pinze senza scarico interno ruotare il pomello in **senso orario**, impostando la **COPPIA MAX**. Collets as per drawing n. 2 must be tightened by setting the maximum torque value and rotating the handle clockwise.

Art./Item	D	L	Nm (dis./dr. 1)	Nm (dis./dr. 2)	Ghiera/Nut
Z052.710.N	32	380	25-35	45-55	ER16
Z052.711.N	35	380	30-40	60-70	ER20
Z052.712.N	40	400	40-55	80-90	ER25
Z052.713.N	50	400	66-70	120-130	ER32
Z052.714.N	63	450	110-120	190-200	ER40

## CHIAVI DINAMOMETRICHE A SETTORE TORQUE HOOK WRENCHES

ART. Z052

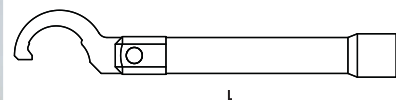

Art./Item	D	L	Nm (dis./dr. 1)	Nm (dis./dr. 2)	Ghiera/Nut
Z052.732.N	58-62	380	110-120	190-200	DIN6388

## SMONTACONI UNIVERSALE REGOLABILE ADJUSTABLE DEMOUNT DEVICES

ART. T139

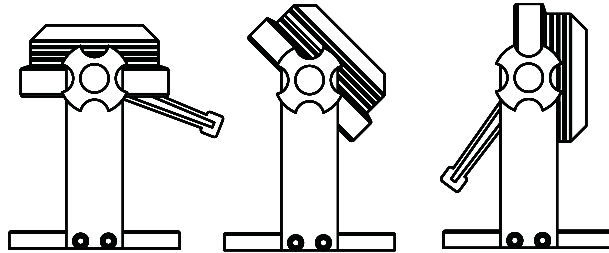

Watch the Video on  
**YouTube**

- Si blocca sul diametro della flangia grazie a una serie di rulli con cuscinetti posti all'interno
- Si può posizionare a piacimento ruotando la flangia da 0° a 90°. - Disponibile per coni HSK32, HSK40, HSK50, HSK63, ISO30 e ISO40
- The tool holder has to be blocked on the flange diameter which is made in special and durable steel
- Auto-locking roller bearing design for the fastest tool changes and no slippage. - It is adjustable from 0° to 90°
- Wide range of tightening stand/locking devices available for HSK32, HSK40, HSK50, HSK63, ISO30 and ISO40 spindles

Articolo/Item	Macchine/Machine
T139.132.N	Per coni HSK32 con flangia Ø 32 mm/For HSK32 tool holder Ø 32 mm
T139.140.N	Per coni HSK40 con flangia Ø 40 mm/For HSK40 tool holder Ø 40 mm
T139.150.N	Per coni ISO 30/HSK50 con flangia Ø 50 mm/For ISO30/HSK50 tool holder Ø 50 mm
T139.158.N	Per coni ISO 30 con flangia Ø 58 mm/For ISO30 tool holder Ø 58 mm (Motori/Motor ELTE/ESSETEAM/THERMWOOD)
T139.163.N	Per coni HSK63 con flangia Ø 63 mm/For HSK63 tool holder Ø 63 mm
T139.164.N	Per coni ISO 40 con flangia Ø 63,5 mm/For ISO 40 tool holder Ø 63,5 mm

### MANUTENZIONE/MACHINES AND TOOLS MAINTENANCE:

Una regolare e **corretta pulizia** degli accoppiamenti fra la sede del cono portautensili nell'elettromandrino, la pinza nel cono portautensili e l'utensile nel foro della pinza è fondamentale per evitare una posizione scorretta dell'utensile durante la lavorazione e il rischio conseguente di scarsa finitura del pezzo o addirittura di rottura dell'utensile. Il materiale lavorato lascia impurità e residui nelle sedi di pinze, coni ed elettromandrini. Una attenta pulizia utilizzando **tamponi pulitori Klein** migliora la lavorazione ed allunga la vita dell'utensile.

*Coupling seats in the electrospindles, in the collet chucks or in the spring collets should be always clean and spotless in order to avoid a wrong position of the tool causing bad finishing results or even tool breakage. By using regularly the tapers Klein these risks are reduced and the tool life span is highly increased.*

### KIT PULIZIA/WIPE OFF KIT

ART. X137



Kit completo per la pulizia dei componenti meccanici delle foratrici punto a punto e pantografi C.N.C. (portautensili e pinze). Scatola in cartone.

*For cleaning all the parts of boring machines and CNC router machines spindle, tool holders and spring collets. Carton box*



Articolo/Item	Cono/Taper	Descrizione/Description	Articolo/Item	Cono/Taper	Descrizione/Description
X137.000.N	HSK63F/ER32	T137.263.N + T137.532.N + X137.004.N	X137.006.N	ISO30/ER40	T137.030.N + T137.540.N + X137.004.N
X137.001.N	ISO30/ER32	T137.030.N + T137.532.N + X137.004.N	X137.010.N	HSK32E/ER25	T137.132.N + T137.525.N + X137.004.N
X137.002.N	HSK63F/DIN6388	T137.263.N + T137.662.N + X137.004.N	X137.011.N	HSK40E/ER25	T137.140.N + T137.525.N + X137.004.N
X137.003.N	HSK25E/ER16	T137.125.N + T137.516.N + X137.004.N	X137.012.N	HSK50E/ER32	T137.150.N + T137.532.N + X137.004.N
X137.005.N	HSK63F/ER40	T137.263.N + T137.540.N + X137.004.N	X137.013.N	HSK50F/ER32	T137.250.N + T137.532.N + X137.004.N

### BARRE DI CONTROLLO / PRECISION TEST BARS

ART. T501

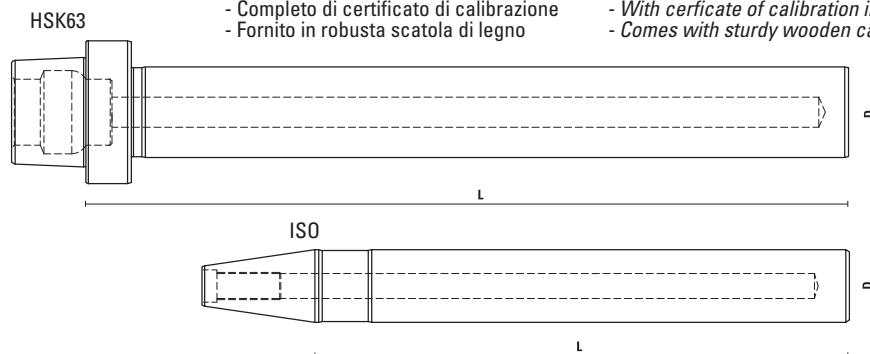

- Concentricità  $\geq 0,003$  mm
- Completo di certificato di calibrazione
- Fornito in robusta scatola di legno

- *Maximum runout error 0,003 mm/3 micron/0.0001 inch*
- *With certificate of calibration included*
- *Comes with sturdy wooden case to protect*

Articolo/Item	Cono/Taper	D	L
T501.080.N	ISO30	32	235
T501.090.N	HSK63F	40	335
T501.095.N	HSK63E	40	335

## FRESE CON COLTELLINI HW PER MATERIALI PLASTICI / HW INSERT ROUTER BITS FOR PLASTIC MATERIAL

ART. W190.RU – WE190.RU – WG190.RU

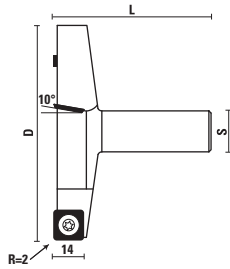

- Particolarmente indicate per spianare larghe superfici di materiali plastici
- Speciale coltellino raggiato (R=2) per una lavorazione meno aggressiva e senza rigature
- **Angolo di taglio 10°** - Si usa su pantografi e su centri di lavoro CNC - Rotazione destra
- Used for **surfacing plastic board material** and making deep rabbet (also known as Flycutters - Spoilboard cutters)
- Special insert knives with radius (R=2) for smoother cuts and no risk of marks and scratch
- **10° shear angle for better performance**
- To be used on machining centres and CNC routers - Right-hand rotation



Angolo di taglio 10°  
10° shear angle

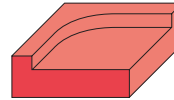

Prodotto venduto comprensivo di chiave per il montaggio/ This item is sold complete with a hex key



Articolo/ Item	D	B	L	Z	S
W190.100.RU	100	14	80	3	∅20x55
W190.101.RU	101,6(4")	14	76(3")	3	∅19,05(3/4")x55



Z051.205.R



Z055.107.N



Z052.205.N

WE190.800.RU	80	14	76	3	∅12x50
WG190.635.RU	63,5(2-1/2")	14	70(2-3/4")	2	∅12,7(1/2")x45



Z051.020.R



Z055.107.N



Z052.103.N

## FRESE CON COLTELLINO HW PER FRESARE A "V" MATERIALI PLASTICI Z=1 RICOPERTE Klein<sup>DIA</sup> HW INSERT V-GROOVE ROUTER BITS Z=1 FOR PLASTIC Klein<sup>DIA</sup> COATED

ART. W171.UKD

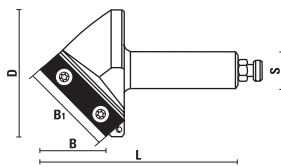

- Si usa su pantografi CNC e su centri di lavoro
- **Coltellino con affilatura speciale per lavorazione materiali plastici con migliore scarico**
- **Coltellino ricoperto per un minor attrito e una migliore fuoriuscita del truciolo**
- Prodotto venduto comprensivo di chiave per il montaggio
- Used on CNC routers and machining centres
- **Special grinding quality of the knives for working plastic with a better evacuation**
- **Coated insert knife for improved chip evacuation and less friction for excellent performance**
- This item is sold complete with a torx key

DURATA  
4/6 VOLTE  
MAGGIORE

UP TO  
4/6X  
TOOL LIFE

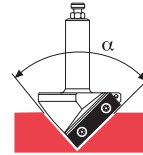

Rot. DX/RH rot.	D	α	B	B1	L	S
W171.670.RUKD	67	91°	33	46,5	97	20
W171.671.RUKD	67	90°	33	46,5	97	20



Z051.402.R



Z052.201.N



Z055.515.NKD

## FRESE HW INTEGRALE ELICA SINISTRA Z=1 SOLID CARBIDE SPIRAL BITS DOWN CUT Z=1

ART. U101

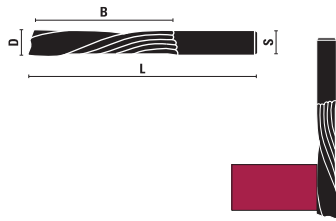

- Rotazione destra con elica sinistra "TIPO SPINGENTE"
- Tagliente lappato per un minore attrito e una migliore fuoriuscita del truciolo
- Per centri di lavoro e pantografi C.N.C.
- Per materie plastiche (preformati di piccolo spessore 3/4 mm), PVC, HDPE, PET, materiali acrilici e superfici solide (CORIAN®)
- Right-hand rotation with "DOWN CUT SPIRAL"
- Polished cutting edge for improved chip evacuation
- Use on CNC and high speed machines
- For working plastic materials (thin prefinished panels, 3/4 mm.), PVC, HDPE, PET, acrylic materials and solid surface

Rot. DX/RH rot.	D	B	L	S
U101.030.R	3	15	50	3
U101.040.R	4	35	70	4
U101.041.R	4	20	60	4
U101.050.R	5	35	70	5
U101.051.R	5	25	60	5
U101.060.R	6	35	80	6
U101.061.R	6	25	70	6
U101.080.R	8	35	80	8
U101.081.R	8	25	70	8
U101.100.R	10	35	80	10
U101.101.R	10	25	70	10
U101.120.R	12	35	80	12

## FRESE HW INTEGRALE ELICA DESTRA Z=1 SOLID CARBIDE SPIRAL BITS UP CUT Z=1

ART. U102

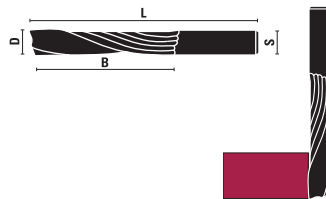

- Rotazione destra con elica destra "TIPO TRAENTE"
- Tagliente lappato per un minore attrito e una migliore fuoriuscita del truciolo
- Per centri di lavoro e pantografi C.N.C.
- Per materie plastiche (sia per preformati di piccolo spessore che lastre piane), fibra di vetro e fenoli
- Right-hand rotation with "UP CUT SPIRAL"
- Polished cutting edge for improved chip evacuation
- Use on CNC and high speed machines
- For working plastic materials, fiberglass, phenols materials and solid surface

Rot. DX/RH rot.	D	B	L	S
U102.040.R	4	35	70	4
U102.050.R	5	35	70	5
U102.060.R	6	35	80	6
U102.080.R	8	35	80	8
U102.100.R	10	35	80	10

## FRESE HW INTEGRALE ELICA DESTRA Z=1 - Z=2 SOLID CARBIDE SPIRAL BITS UP CUT Z=1 - Z=2

ART. U111 - U112

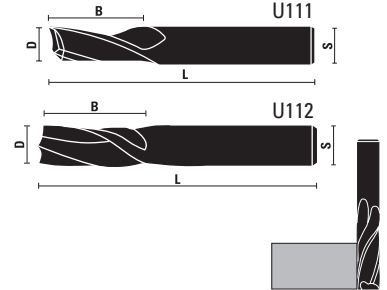

- Rotazione destra con elica destra "TIPO TRAENTE"
- Tagliente lappato per un minore attrito e una migliore fuoriuscita del truciolo
- Per centri di lavoro e pantografi C.N.C.
- Per alluminio, plastica, fibra di vetro e fenoli
- Right-hand rotation with "UP CUT SPIRAL"
- Polished cutting edge for improved chip evacuation
- Use on CNC and high speed machines
- For working aluminium, plastic materials, fiberglass, phenols materials and solid surface

Rot. DX/RH rot.	D	B	L	S	Z
U111.030.R	3	12	60	6	1
U111.032.R	1/8"	1/2"	2"	1/4"	1
U111.040.R	4	12	60	6	1
U111.048.R	3/16"	5/8"	2"	1/4"	1
U111.050.R	5	16	60	6	1
U111.060.R	6	16	60	6	1
U111.061.R	6	35	80	6	1
U111.064.R	1/4"	3/4"	2"	1/4"	1
U111.080.R	8	18	60	8	1
U111.081.R	8	35	80	8	1
U111.095.R	3/8"	3/4"	3"	3/8"	1
U111.100.R	10	22	70	10	1
U111.101.R NEW	10	25	90	10	1
U111.120.R	12	24	70	12	1
U111.127.R	1/2"	1-1/4"	3"	1/2"	1
U112.040.R	4	10	60	6	2
U112.048.R	3/16"	1/2"	2"	1/4"	2
U112.050.R	5	12	60	6	2
U112.060.R	6	15	60	6	2
U112.064.R	1/4"	3/4"	2"	1/4"	2
U112.080.R	8	20	60	8	2
U112.095.R	3/8"	1"	3"	3/8"	2
U112.100.R	10	22	70	10	2
U112.120.R	12	25	80	12	2
U112.127.R	1/2"	1-1/2"	3-1/2"	1/2"	2
U112.140.R	14	25	80	14	2
U112.160.R	16	25	80	16	2

Per frese da  $\varnothing$  12 a  $\varnothing$  16 si esegue sede per anello di ritegno (Seeger)  
Router bits with diameter from 12 mm to 16 mm, are produced with shank fit for Seeger retaining rings



## FRESE HW INTEGRALE ELICA DESTRA Z=2 / SOLID CARBIDE SPIRAL BITS UP CUT Z=2

ART. U120

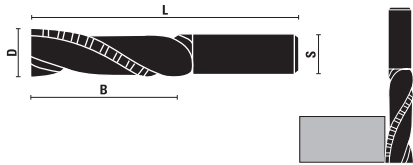

- Rotazione destra con elica destra "TIPO TRAENTE"
- Taglienti con rompitruciolo
- Tagliente lappato per un minore attrito e una migliore fuoriuscita del truciolo
- Per lavorazione legno/alluminio
- Right-hand rotation with "UP CUT SPIRAL"
- With chip-breaker
- Polished cutting edge for improved chip evacuation
- For working wood and aluminium material

Rot. DX/RH rot.	D	B	L	S
U120.140.R	14	42	100	14
U120.160.R	16	42	100	16
U120.180.R	18	62	120	18
U120.200.R	20	62	120	20

# KleinDIA®

## DLC COATING FOR EXCELLENT PERFORMANCE AND LONGER LIFETIME



**KleinDIA®** is the most advantageous coating, ensuring:

- Production increase
- Better finishing
- Less maintenance
- Longer lifetime

### TECHNICAL FEATURES:

- High hardness Hv0,025: 2500-3100
- Higher wear resistance (longer working time)
- Low frictional coefficient (lowered working temperature)
- Very low sticking coefficient (Better chips evacuation)
- Thickness: appr. 1 micron
- Colour: bright black

## FRESE HW INTEGRALE ELICA DESTRA Z=1 RICOPERTE KleinDIA

### SOLID CARBIDE SPIRAL BITS UP CUT Z=1 KleinDIA COATED

ART. U102.KD



DURATA  
**4/6 VOLTE**  
MAGGIORE

UP TO  
**4/6X**  
TOOL LIFE



- Rotazione destra con elica destra "TIPO TRAENTE"
- Tagliente lappato per un minore attrito e una migliore fuoriuscita del truciolo
- Per centri di lavoro e pantografi C.N.C.
- Per materie plastiche (sia per preformati di piccolo spessore che lastre piane), fibra di vetro e fenoli
- Right-hand rotation with "UP CUT SPIRAL"
- Polished cutting edge for improved chip evacuation
- Use on CNC and high speed machines
- For working plastic materials, fiberglass, phenols materials and solid surface

Rot. DX/RH rot.	D	B	L	S
U102.040.RKD	4	35	70	4
U102.050.RKD	5	35	70	5
U102.060.RKD	6	35	80	6
U102.080.RKD	8	35	80	8
U102.100.RKD	10	35	80	10

## FRESE HW INTEGRALE ELICA SINISTRA Z=1 RICOPERTE KleinDIA SOLID CARBIDE SPIRAL BITS DOWN CUT Z=1 KleinDIA COATED

ART. U101.KD

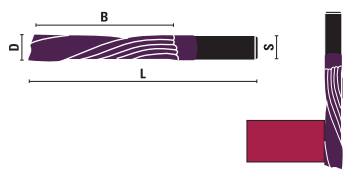

DURATA  
**4/6 VOLTE**  
MAGGIORE

UP TO  
**4/6X**  
TOOL LIFE

- Rotazione destra con elica sinistra "TIPO SPINGENTE"
- Tagliente lappato per un minore attrito e una migliore fuoriuscita del truciolo
- Per centri di lavoro e pantografi C.N.C.
- Per materie plastiche (preformati di piccolo spessore 3/4 mm), PVC, HDPE, PET, materiali acrilici e superfici solide (CORIAN®)
- Right-hand rotation with "DOWN CUT SPIRAL"
- Polished cutting edge for improved chip evacuation
- Use on CNC and high speed machines
- For working plastic materials (thin prefinished panels, 3/4 mm.), PVC, HDPE, PET, acrylic materials and solid surface

Rot. DX/RH rot.	D	B	L	S
U101.030.RKD	3	15	50	3
U101.040.RKD	4	35	70	4
U101.041.RKD	4	20	60	4
U101.050.RKD	5	35	70	5
U101.051.RKD	5	25	60	5
U101.060.RKD	6	35	80	6
U101.061.RKD	6	25	70	6
U101.080.RKD	8	35	80	8
U101.081.RKD	8	25	70	8
U101.100.RKD	10	35	80	10
U101.101.RKD	10	25	70	10
U101.120.RKD	12	35	80	12

## FRESE HW INTEGRALE ELICA DESTRA Z=2 RICOPERTE KleinDIA SOLID CARBIDE SPIRAL BITS UP CUT Z=2 KleinDIA COATED

ART. U120.KD

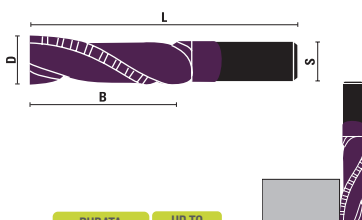

DURATA  
**4/6 VOLTE**  
MAGGIORE

UP TO  
**4/6X**  
TOOL LIFE

- Rotazione destra con elica destra "TIPO TRAENTE"
- Taglienti con rompitruciolo
- Tagliente lappato e ricoperto per un minore attrito e una migliore fuoriuscita del truciolo
- Per lavorazione legno/alluminio
- Per centri di lavoro e pantografi C.N.C.
- Right-hand rotation with "UP CUT SPIRAL"
- With chip-breaker
- Polished and coated cutting edge for improved evacuation and less friction
- For working wood and aluminium material
- Use on CNC and high speed machines

Rot. DX/RH rot.	D	B	L	S
U120.140.RKD	14	42	100	14
U120.160.RKD	16	42	100	16
U120.180.RKD	18	62	120	18
U120.200.RKD	20	62	120	20

## FRESE HW INTEGRALE ELICA DESTRA Z=1 - Z=2 SOLID CARBIDE SPIRAL BITS UP CUT Z=1 - Z=2

ART. U111.KD - U112.KD

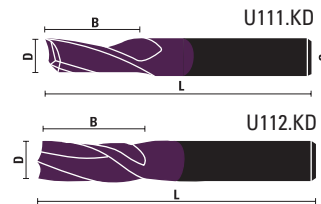

DURATA  
**4/6 VOLTE**  
MAGGIORE

UP TO  
**4/6X**  
TOOL LIFE

KleinDIA



- Rotazione destra con elica destra "TIPO TRAENTE"
- Tagliente lappato per un minore attrito e una migliore fuoriuscita del truciolo
- Per centri di lavoro e pantografi C.N.C.
- Per alluminio, plastica, fibra di vetro e fenoli
- Right-hand rotation with "UP CUT SPIRAL"
- Polished cutting edge for improved chip evacuation
- Use on CNC and high speed machines
- For working aluminium, plastic materials, fiberglass, phenols materials and solid surface

Rot. DX/RH rot.	D	B	L	S	Z
U111.030.RKD	3	12	60	6	1
U111.032.RKD	1/8"	1/2"	2"	1/4"	1
U111.040.RKD	4	12	60	6	1
U111.048.RKD	3/16"	5/8"	2"	1/4"	1
U111.050.RKD	5	16	60	6	1
U111.060.RKD	6	16	60	6	1
U111.061.RKD	6	35	80	6	1
U111.064.RKD	1/4"	3/4"	2"	1/4"	1
U111.080.RKD	8	18	60	8	1
U111.081.RKD	8	35	80	8	1
U111.095.RKD	3/8"	3/4"	3"	3/8"	1
U111.100.RKD	10	22	70	10	1
U111.101.RKD <b>NEW</b>	10	25	90	10	1
U111.120.RKD	12	24	70	12	1
U111.127.RKD	1/2"	1-1/4"	3"	1/2"	1

U112.040.RKD	4	10	60	6	2
U112.048.RKD	3/16"	1/2"	2"	1/4"	2
U112.050.RKD	5	12	60	6	2
U112.060.RKD	6	15	60	6	2
U112.064.RKD	1/4"	3/4"	2"	1/4"	2
U112.080.RKD	8	20	60	8	2
U112.095.RKD	3/8"	1"	3"	3/8"	2
U112.100.RKD	10	22	70	10	2
U112.120.RKD	12	25	80	12	2
U112.127.RKD	1/2"	1-1/2"	3-1/2"	1/2"	2
U112.140.RKD	14	25	80	14	2
U112.160.RKD	16	25	80	16	2

## FRESE HW A "T" Z=4 / T-SLOT HW CUTTERS Z=4

ART. C173

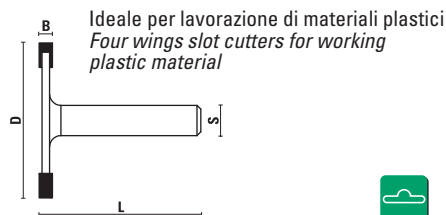

Ideale per lavorazione di materiali plastici  
Four wings slot cutters for working plastic material

S Ø 8	D	B	L
C173.020.R	41	2	43
C173.025.R	41	2,5	43
C173.030.R	41	3	44
C173.035.R	41	3,5	44
C173.040.R	41	4	45
C173.045.R	41	4,5	45
C173.050.R	41	5	46

## FRESE HW INTEGRALE ELICA DESTRA Z=5 PER SUPERFINITURA, RICOPERTE KleinDIA SOLID CARBIDE SPIRAL CUTTERS Z=5 SUPER-FINISHING KleinDIA COATED

ART. U115.KD



DURATA  
**4/6 VOLTE**  
MAGGIORE

UP TO  
**4/6X**  
TOOL LIFE

- Per lavorazione di plexiglass e acrilici
- Rotazione destra con elica destra "TIPO TRAENTE"
- Tagliente lappato e ricoperto per un minore attrito e una migliore fuoriuscita del truciolo. Elevate prestazioni.
- Per centri di lavoro e pantografi C.N.C.
- Ideale per lucidatura e migliore finitura superficiale
- For working plexiglass and acrylic
- Right-hand rotation with "UP CUT SPIRAL"
- Polished and coated cutting edge for improved chip evacuation and less friction for excellent performance
- To be used on machining centres and CNC routers
- Especially made for plexiglass polishing and best finishing cuts

Rot. DX/Rh Rot.	D	B	L	S
U115.060.RKD	6	25	70	6
U115.080.RKD	8	30	80	8
U115.100.RKD	10	35	80	10

## FRESE IN HW INTEGRALE PER VETRORESINA, KleinDIA SOLID CARBIDE BITS FOR FIBERGLASS WORKING KleinDIA COATED

ART. U130.KD



DURATA  
**4/6 VOLTE**  
MAGGIORE

UP TO  
**4/6X**  
TOOL LIFE

- Per lavorazione di materie plastiche, gomma dura e fibra di vetro
- Per contornare e rasare frontale
- Da utilizzare su fresatrici, pantografi CNC e macchine portatili
- For working plastic materials, rubber and fiberglass
- For routing and shearing
- To be used on portable machines, CNC and routing machines

Rot. DX/RH rot.	D	B	L	S
U130.030.RKD	3	12	38	3
U130.040.RKD	4	15	40	4
U130.050.RKD	5	18	50	5
U130.060.RKD	6	22	55	6
U130.064.RKD	1/4"	1"	3"	1/4"
U130.080.RKD	8	30	70	8
U130.095.RKD	3/8"	1-1/4"	3-1/4"	3/8"
U130.100.RKD	10	30	72	10
U130.120.RKD	12	30	73	12
U130.127.RKD	1/2"	1-1/2"	3-1/2"	1/2"

## FRESE HW INTEGRALE ELICA DESTRA Z=2 SOLID CARBIDE SPIRAL BITS DOWN CUT Z=2

ART. U150

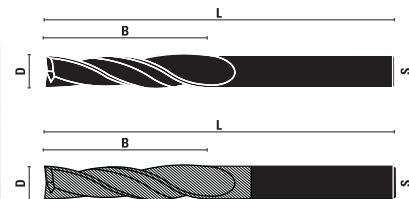

- "RT" con speciale ricopertura al **TICN** per lavorazione acciaio inox e materiali ferrosi
- Per centri di lavoro C.N.C.
- Per lavorazione **alluminio** e materiali ferrosi
- "RT" with special coating **TICN** for working inox and ferrous materials
- Use on CNC machines
- For working **aluminum** and ferrous materials

Rot. DX/RH rot.	D	B	L	S
U150.060.R	6	16	60	6
U150.080.R	8	45	100	8
U150.100.R	10	22	70	10
U150.060.RT	6	16	60	6
U150.080.RT	8	45	100	8
U150.100.RT	10	22	70	10

## FRESE HW INTEGRALE ELICA DESTRA Z=4 SOLID CARBIDE SPIRAL BITS DOWN CUT Z=4

ART. U155 - U156

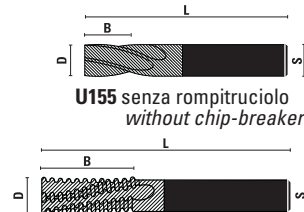

U155 senza romptruciolo  
without chip-breaker



U156 con romptruciolo  
with chip-breaker

- "RT" con speciale ricopertura al "**TINALOX**"
- Per centri di lavoro C.N.C.
- Per lavorazione **acciaio inox** e materiali ferrosi
- "RT" with special coating "**TINALOX**"
- Use on CNC machines
- For working **inox** and ferrous materials

Rot. DX/RH rot.	D	B	L	S	Z
U155.060.RT	6	15	60	6	4
U155.080.RT	8	19	65	8	4
U156.060.RT	6	21	60	6	4
U156.080.RT	8	25	70	8	4

romptruciolo chip-breaker

## FRESE A DUE DIAMETRI IN HW INTEGRALE ELICA DESTRA Z=1 SOLID CARBIDE DOUBLE DIAMETER SPIRAL BITS Z=1

ART. U190



- Rotazione destra con elica destra "TIPO TRAENTE"
- Per centri di lavoro C.N.C.
- Per lavorazione **alluminio** e metalli non ferrosi
- Right-hand rotation with "UP CUT SPIRAL"
- Use on CNC machines
- For working **aluminum** and non-ferrous materials

Rot. DX/RH rot.	d	D	B	I	L	S
U190.030.R	3	8	5	30	80	8
U190.055.R	5,5	8	10	25	100	8
U190.060.R	6	11,5	10	40	100	12

## FRESE HW INTEGRALE ELICA DESTRA Z=1 - Z=2 TIPO LUNGO SOLID CARBIDE SPIRAL BITS UP CUT Z=1 - Z=2 LONG TYPE

ART. U121 - U122

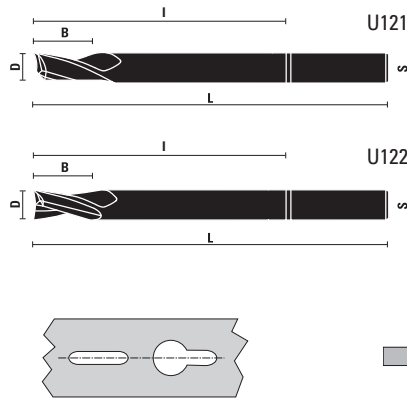

- **Rotazione destra** con elica destra "**TIPO TRAENTE**"
- Tagliante lappato per un minore attrito e una migliore fuoriuscita del truciolo
- Per centri di lavoro e pantografi C.N.C.
- Si consiglia l'utilizzo con refrigerante/lubrificante
- Versione lunga ideale per **lavorazioni in profondità**
- Per:
  - alluminio
  - fenoli
  - plastica
  - acrilici
  - fibra di vetro
  - PVC
- **Right-hand rotation with "UP CUT SPIRAL"**
- Polished cutting edge for improved chip evacuation. Mirror finish
- Spiral 'O' flute sharpening
- Long version for **deep machining operations**
- Use on CNC and high speed machines
- Use with coolant/lubricant is recommended
- For working:
  - aluminium
  - phenolic
  - fiberglass
  - acrylic
  - plastic
  - PVC

Rotaz. Dx/RH rotation	D	B/l	L	S	Z
U121.040.R	4	14/40	100	8	1
U121.050.R	5	18/50	100	8	1
U121.060.R	6	20/50	100	8	1
U121.080.R	8	20/70	100	8	1
U121.100.R	10	20/70	100	10	1
U121.120.R	12	35/70	100	12	1
U121.140.R <b>NEW</b>	14	35/70	100	14	1
U122.050.R	5	18/50	100	8	2
U122.080.R	8	20/70	100	8	2
U122.100.R	10	25/70	100	10	2

## FRESE HW INTEGRALE ELICA DESTRA Z=1 - TIPO CORTO SOLID CARBIDE SPIRAL BITS UP CUT Z=1 - SHORT TYPE

ART. U125

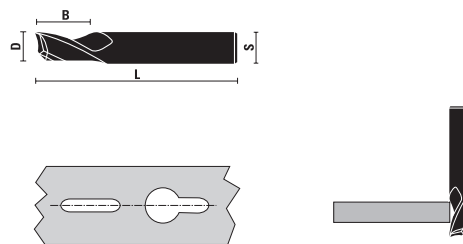

- **Rotazione destra** con elica destra "**TIPO TRAENTE**"
- Tagliante lappato per un minore attrito e una migliore fuoriuscita del truciolo
- Per centri di lavoro e pantografi C.N.C.
- Si consiglia l'utilizzo con refrigerante/lubrificante
- Versione con tagliante corto per **diminuire le vibrazioni**, aumentare la stabilità e una migliore finitura
- Per:
  - alluminio
  - fenoli
  - plastica
  - acrilici
  - fibra di vetro
  - PVC
- **Right-hand rotation with "UP CUT SPIRAL"**
- Polished cutting edge for improved chip evacuation. Mirror finish
- Spiral 'O' flute sharpening
- Shorter cutting edge spiral version to **reduce vibration**, increase stability and have a better finish
- Use on CNC and high speed machines
- Use with coolant/lubricant is recommended
- For working:
  - aluminium
  - phenolic
  - fiberglass
  - acrylic
  - plastic
  - PVC

Rotaz. Dx/RH rotation	D	B	L	S	Z
U125.040.R	4	8	50	6	1
U125.050.R	5	10	50	6	1
U125.060.R	6	12	50	6	1



## FRESE HW INTEGRALE ELICA DESTRA Z=1 - Z=2 TIPO LUNGO, RICOPERTE Klein<sup>DIA</sup> SOLID CARBIDE SPIRAL BITS UP CUT Z=1 - Z=2 LONG TYPE, Klein<sup>DIA</sup> COATED

ART. U121.KD - U122.KD

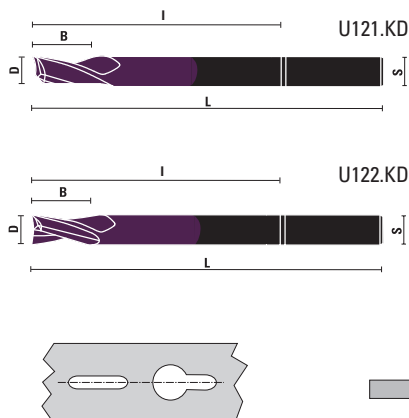

DURATA  
**4/6 VOLTE**  
MAGGIORE

UP TO  
**4/6X**  
TOOL LIFE

- Rotazione destra con elica destra "TIPO TRAENTE"
- **Elevatissima durata dell'utensile e migliori performance**
- Tagliante lappato per un minore attrito e una migliore fuoriuscita del truciolo
- Per centri di lavoro e pantografi C.N.C.
- Si consiglia l'utilizzo con refrigerante/lubrificante
- Versione lunga ideale per lavorazioni in profondità
- Per: • alluminio • plastica • fibra di vetro • fenoli • acrilici • PVC
- **Right-hand rotation with "UP CUT SPIRAL"**
- **Longer tool life and greater cutting quality**
- Polished cutting edge for improved chip evacuation. Mirror finish
- Spiral 'O' flute sharpening
- Long version for **deep machining operations**
- Use on CNC and high speed machines
- Use with coolant/lubricant is recommended
- For working: • aluminium • fiberglass • plastic • phenolic • acrylic • PVC

Rotaz. Dx/RH rotation	D	B/l	L	S	Z
U121.040.RKD	4	14/40	100	8	1
U121.050.RKD	5	18/50	100	8	1
U121.060.RKD	6	20/50	100	8	1
U121.080.RKD	8	20/70	100	8	1
U121.100.RKD	10	20/70	100	10	1
U121.120.RKD	12	35/70	100	12	1
U121.140.RKD <b>NEW</b>	14	35/70	100	14	1
U122.050.RKD	5	18/50	100	8	2
U122.080.RKD	8	20/70	100	8	2
U122.100.RKD	10	25/70	100	10	2

## FRESE HW INTEGRALE ELICA DESTRA Z=1 TIPO CORTO, RICOPERTE Klein<sup>DIA</sup> SOLID CARBIDE SPIRAL BITS UP CUT Z=1 SHORT TYPE Klein<sup>DIA</sup> COATED

ART. U125.KD

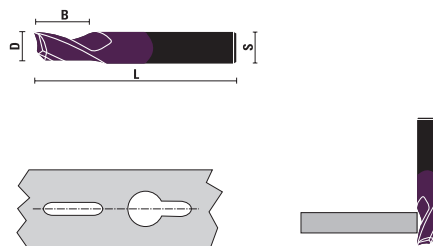

DURATA  
**4/6 VOLTE**  
MAGGIORE

UP TO  
**4/6X**  
TOOL LIFE

- Rotazione destra con elica destra "TIPO TRAENTE"
- **Elevatissima durata dell'utensile e migliori performance**
- Tagliante lappato per un minore attrito e una migliore fuoriuscita del truciolo
- Per centri di lavoro e pantografi C.N.C.
- Si consiglia l'utilizzo con refrigerante/lubrificante
- Versione con tagliante corto per **diminuire le vibrazioni**, aumentare la stabilità e una migliore finitura
- Per: • alluminio • plastica • fibra di vetro • fenoli • acrilici • PVC
- **Right-hand rotation with "UP CUT SPIRAL"**
- **Longer tool life and greater cutting quality**
- Polished cutting edge for improved chip evacuation. Mirror finish
- Spiral 'O' flute sharpening
- Shorter cutting edge spiral version to **reduce vibration**, increase stability and have a better finish
- Use on CNC and high speed machines
- Use with coolant/lubricant is recommended
- For working: • aluminium • fiberglass • plastic • phenolic • acrylic • PVC

Rotaz. Dx/RH rotation	D	B	L	S	Z
U125.040.RKD	4	8	50	6	1
U125.050.RKD	5	10	50	6	1
U125.060.RKD	6	12	50	6	1

## FRESE HS-E ELICOIDALI PER ALLUMINIO Z=1 HS UPCUT SPIRAL BITS FOR ALUMINIUM Z=1

ART. U201 - U211 - U221

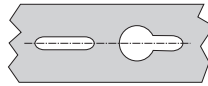
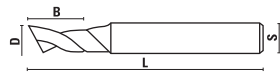

- Costruite con acciaio HS al 5% cobalto
- Rotazione destra con elica destra "TIPO TRAENTE"
- Da usare su profilati in alluminio
- Per forare e contornare
- Usare con lubrificante
- *Manufactured in HS 5% cobalt*
- *Right-hand rotation with "UP CUT SPIRAL"*
- *Used for alu profiles*
- *Plunging and routing*
- *Use with lubricant*

Rot. DX/RH rot.	D	B	L	S	Z
U201.030.R	3	12	60	8	1
U201.040.R	4	12	60	8	1
U201.041.R	4	40	100	8	1
U201.042.R	4	12	100	8	1
U201.050.R	5	14	70	8	1
U201.051.R	5	40	100	8	1
U201.052.R	5	14	100	8	1
U201.053.R	5	14	120	8	1
U201.054.R	5	25	70	8	1
U201.055.R	5	25	100	8	1
U201.056.R	5	40	120	8	1
U201.060.R	6	14	70	8	1
U201.061.R	6	40	100	8	1
U201.062.R	6	14	100	8	1
U201.063.R	6	25	70	8	1
U201.070.R	7	14	70	8	1
U201.080.R	8	14	80	8	1
U201.081.R	8	30	100	8	1
U201.082.R	8	14	100	8	1
U201.083.R	8	14	120	8	1
U201.084.R	8	25	80	8	1
U201.085.R	8	25	120	8	1
U201.090.R	9	14	80	8	1
U201.100.R	10	14	80	8	1
U201.101.R	10	14	100	8	1
U201.102.R	10	14	120	8	1
U201.120.R	12	14	80	8	1
U211.030.R	3	12	60	6	1
U211.040.R	4	12	60	6	1
U211.050.R	5	14	60	6	1
U211.060.R	6	14	60	6	1
U211.061.R	6	27	70	6	1
U221.030.R	3	12	60	10	1
U221.040.R	4	12	60	10	1
U221.050.R	5	14	60	10	1
U221.060.R	6	14	60	10	1
U221.080.R	8	14	80	10	1
U221.100.R	10	14	80	10	1
U221.101.R	10	14	120	10	1
U221.120.R	12	14	80	10	1

## FRESE HS-E ELICOIDALI PER ALLUMINIO TIPO LUNGO Z=1 HS UPCUT SPIRAL BITS FOR ALUMINIUM Z=1

ART. U202

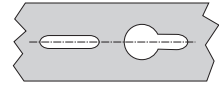
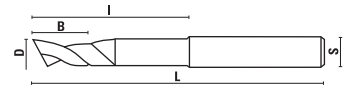

- Costruite con acciaio HS al 5% cobalto
- Rotazione destra con elica destra "TIPO TRAENTE"
- Da usare su profilati in alluminio
- Per forare e contornare
- Usare con lubrificante
- Con stelo ridotto
- *Manufactured in HS 5% cobalt*
- *Right-hand rotation with "UP CUT SPIRAL"*
- *Used for alu profiles*
- *Plunging and routing*
- *Use with lubricant*
- *Reduced throat execution*

Rot. DX/RH rot.	D	B/l	L	S	Z
U202.040.R	4	16/55	90	8	1
U202.050.R	5	14/35	80	8	1
U202.051.R	5	14/35	120	8	1
U202.052.R	5	16/55	90	8	1
U202.053.R	5	18/35	100	8	1
U202.054.R	5	20/45	100	8	1
U202.055.R	5	20/55	80	10	1
U202.056.R	5	20/55	100	10	1
U202.060.R	6	14/55	85	8	1
U202.061.R	6	14/35	80	8	1
U202.062.R	6	14/45	90	8	1
U202.063.R	6	20/55	100	10	1
U202.080.R	8	14/60	80	8	1
U202.081.R	8	14/90	120	8	1
U202.082.R	8	14/70	100	8	1
U202.083.R	8	30/70	100	8	1
U202.100.R	10	14/60	80	10	1
U202.101.R	10	14/70	100	10	1
U202.102.R	10	14/95	120	10	1
U202.103.R	10	30/70	100	10	1

## SET DI FRESE PER ALLUMINIO/SET FOR ALU

ART. X015



Cassetta in legno/Wooden box

### Articolo/Item

X015.009.R

Set composto da 9 pz/9-pcs set for alu:

U201.030.R - U201.040.R - U201.050.R - U201.060.R - U201.080.R  
U201.100.R - U202.050.R - U202.060.R - U202.080.R



## FRESE HS-E ELICOIDALI PER ALLUMINIO Z=1, RICOPERTE KleinDIA HS UPCUT SPIRAL BITS FOR ALUMINIUM Z=1, KleinDIA COATED

ART. U201.KD

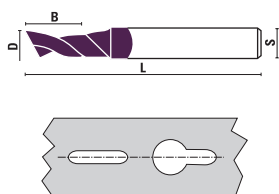

**DURATA**  
**4/6 VOLTE**  
**MAGGIORE**

**UP TO**  
**4/6X**  
**TOOL LIFE**

- Costruite con acciaio HS al 5% cobalto
- Rotazione destra con elica destra "TIPO TRAENTE"
- **Tagliente lappato per un minore attrito e una migliore fuoriuscita del truciolo**
- Da usare su profilati in alluminio
- Per forare e contornare
- Usare con lubrificante

- *Manufactured in HS 5% cobalt*
- *Right-hand rotation with "UP CUT SPIRAL"*
- **Polished cutting edge for improved chip evacuation and less friction**
- *Used for alu profiles*
- *Plunging and routing*
- *Use with lubricant*

Rot. DX/RH rot.	D	B	L	S
U201.040.RKD	4	12	60	8
U201.050.RKD	5	14	70	8
U201.060.RKD	6	14	70	8
U201.080.RKD	8	14	70	8
U201.081.RKD	8	30	100	8
U201.100.RKD	10	14	80	10

## FRESE HS-E ELICOIDALI PER ALLUMINIO Z=1 TIPO LUNGO, RICOPERTE KleinDIA HS UPCUT SPIRAL BITS FOR ALUMINIUM Z=1 LONG TYPE, KleinDIA COATED

ART. U202.KD

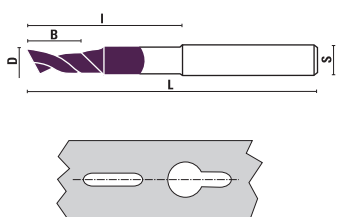

**DURATA**  
**4/6 VOLTE**  
**MAGGIORE**

**UP TO**  
**4/6X**  
**TOOL LIFE**

- Costruite con acciaio HS al 5% cobalto
- Rotazione destra con elica destra "TIPO TRAENTE"
- **Tagliente lappato per un minore attrito e una migliore fuoriuscita del truciolo**
- Da usare su profilati in alluminio
- Per forare e contornare
- Con stelo ridotto
- Usare con lubrificante

- *Manufactured in HS 5% cobalt*
- *Right-hand rotation with "UP CUT SPIRAL"*
- **Polished cutting edge for improved chip evacuation and less friction**
- *Used for alu profiles*
- *Plunging and routing*
- *Reduced throat execution*
- *Use with lubricant*

Rot. DX/RH rot.	D	B/l	L	S
U202.050.RKD	5	14/35	80	8
U202.080.RKD	8	14/60	80	8
U202.083.RKD	8	30/70	100	8
U202.102.RKD	10	14/95	120	10

## FRESE HW INTEGRALE ELICA DESTRA Z=2, RICOPERTE KleinDIA SOLID CARBIDE SPIRAL CUTTERS Z=2, KleinDIA COATED

ART. U302.KD

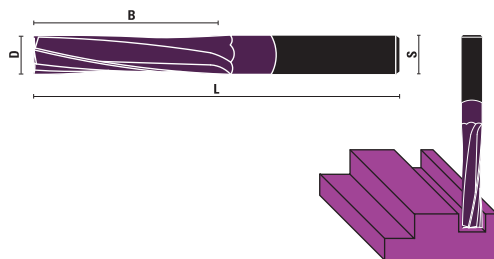

**DURATA**  
**4/6 VOLTE**  
**MAGGIORE**

**UP TO**  
**4/6X**  
**TOOL LIFE**

- Per lavorazione di materiali compositi (Corian® - Avonite®)
- Rotazione destra con elica destra "TIPO TRAENTE"
- **Tagliente lappato per un minore attrito e una migliore fuoriuscita del truciolo in lavorazione consentendo una migliore resa e maggiore durata dell'utensile**
- Inclinazione dell'elica specifica per lavorare materiali compositi
- Utilizzo di widia specifico per una migliore qualità di taglio

- **For working Solid Surface (Corian® - Avonite®)**
- *Right-hand rotation with "UP CUT SPIRAL"*
- **Polished cutting edge for improved chip evacuation and less friction by allowing better quality cuts and longer tool life**
- *Special shear angle for working solid surface without breakage*
- *Specific solid carbide for best cutting quality*

Rot. DX/RH Rot.	D	B	L	S
U302.080.RKD	8	32	80	8
U302.100.RKD	10	42	100	10
U302.120.RKD	12	42	100	12
U302.160.RKD	16	62	120	16

## FRESE HS A DUE DIAMETRI PER ALLUMINIO Z=2 HS DOUBLE DIAMETER SPIRAL BITS FOR ALUMINIUM Z=2

ART. U230

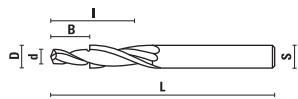

Rot. DX/RH Rot.	d/D	B/l	L	S
U230.030.R	3/6	8/15	60	6

## FRESE HS A TAGLIANTE DIRITTO PER PVC Z=1 HS SPECIAL BITS FOR PVC Z=1

ART. U240

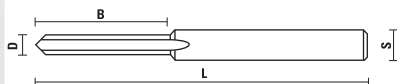

- Con punta per forare
- Per profili in PVC su macchine **Elumatec, Rotox, Striffler** etc.
- *Plunging*
- For working PVC profiles on **Elumec, Rotox, Striffler** machines

Rot. DX/RH Rot.	D	B	L	S
U240.050.R	5	35	102	8
U240.051.R	5	45	102	8
U240.052.R	5	55	102	8
U240.060.R	6	30	102	8

## FRESE HS A TAGLIANTE ELICOIDALE PER PVC Z=2 HS SPECIAL BITS FOR PVC Z=2

ART. U241

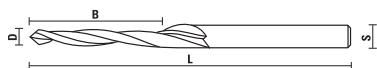

- Con punta per forare
- Per foro passante
- Per profili in PVC su macchine **Elumatec, Rotox, Striffler** etc.
- *Through hole execution*
- For working PVC profiles on **Elumec, Rotox, Striffler** machines

Rot. DX/RH Rot.	D	B	L	S
U241.050.R	5	40	100	8

## FRESE HS A TAGLIANTI ELICOIDALI PER ALLUMINIO Z=2-Z=3 HS UPCUT SPIRAL CUTTERS FOR ALUMINIUM Z=2-Z=3

ART. U250

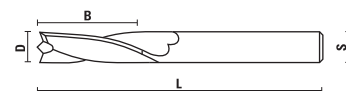

- Costruite con acciaio HS al **5% cobalt**
  - Rotazione destra con elica destra "TIPO TRAEUTE"
  - Da utilizzare su pantografi C.N.C. e fresatrici
  - Per lavorazione **alluminio** e **materiali ferrosi**
- *Manufactured in HS 5% cobalt*  
 - *Right-hand rotation with "UP CUT SPIRAL"*  
 - *Use on CNC and milling machines*  
 - *For working aluminum and ferrous materials*

Rot. DX/RH Rot.	D	B	L	S	Z
U250.040.R	4	12	63	6	2
U250.050.R	5	25	68	6	2
U250.060.R	6	25	68	6	2
U250.080.R	8	25	88	8	2
U250.100.R	10	35	95	10	2
U250.120.R	12	35	110	12	2
U250.140.R	14	37	110	14	3
U250.160.R	16	40	123	16	3
U250.180.R	18	40	123	18	3
U250.200.R	20	45	130	20	3

## PUNTE HS PER FORARE PVC E ALLUMINIO Z=2 HS DRILLING BITS FOR PVC AND ALUMINIUM WORKING Z=2

ART. U260

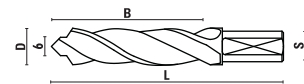

- Da utilizzare su ns. attrezzatura **Trimatic 43/0**
- Per fori inserimento maniglie su **PVC** e **alluminio**
- *To be used on our Trimatic 43/0 boring jigs for mounting cremona bolt on PVC and/or aluminium doors and windows*

Rot. DX/RH Rot.	Rot. SX/LH Rot.	D	B	L	S
	U260.080.L	8	50	76	10x20
	U260.100.L	10	50	76	10x20
U260.120.R	U260.120.L	12	50	76	10x20
U260.140.R		14	50	76	10x20

**Schema di foratura di alcune ferramenta/Some examples of drilling patterns**

### SIEGENIA-TRIAL WEIDTMANN-KURLER

U260.120.L	2	U260.100.L	2
U260.120.R	1	U260.140.R	1

### G-U JET77 OLIVEN

U260.100.L	2	U260.080.L	2
U260.120.R	1	U260.120.R	1

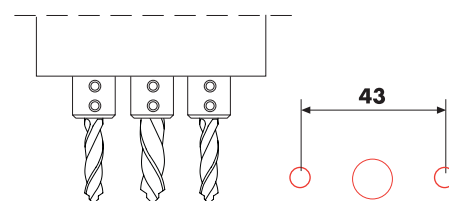

Sx/Lh Dx/Rh Sx/Lh

Trimatic 43/0  
(Vedi pag. /See pag. 35)

## PUNTE HS PER FORARE PVC E ALLUMINIO Z=2

### HS DRILLING BITS FOR PVC AND ALUMINIUM WORKING Z=2

ART. U270

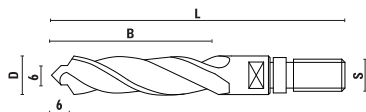

Per fori inserimento maniglie su **PVC** e **alluminio**

To produce holes for inserting handles on **PVC** and **aluminium** workpieces

Rot. DX/RH Rot.	Rot. SX/LH Rot.	D	B	L	S
	U270.080.L	8	50	93	M10
	U270.100.L	10	50	93	M10
	U270.120.L	12	49	93	M10
U270.120.R		12	55	98	M10
U270.140.R		14	55	98	M10

## FRESE HW PER LAVORAZIONE ALUCOBOND® Z=2

### HW DRILLS FOR WORKING ALUCOBOND® Z=2

ART. U180

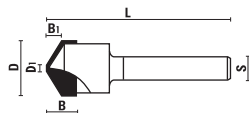

U180

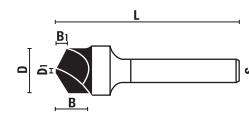

U181

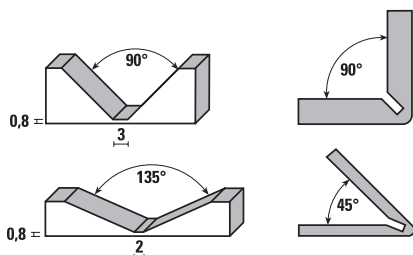

Appositamente studiata per intagliare pannelli di **ALUCOBOND®**, **ALUPANEL®**, **DIBOND®**, **STACBOND®** con angoli a 90° e 135° (a fondo piatto), rendendo la piegatura dei pannelli un'operazione semplice e senza il rischio di rottura.

*Especially designed for scoring **ALUCOBOND®**, **ALUPANEL®**, **DIBOND®**, **STACBOND®** materials with 90° and 135° angles (with flat bottoms), thus allowing a simple hand bending operation of the panel without cracking.*



S	8	D	D1	α	B	B1	L
U180.090.R		18	3	90°	10	8	60
U180.135.R		18	2	135°	10	3,3	60
U181.090.R		18	3	90°	10	8	60
U181.135.R		18	2	135°	10	3,3	60

## PUNTE PER CERNIERE IN HW PER ALLUMINIO Z=2

### HW HINGE BORING BITS FOR ALUMINIUM Z=2

ART. U140

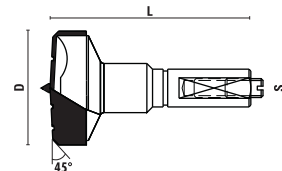

- Esecuzione Z=2 con **rompitruciolo**
- Per lavorazione alluminio
- **Chip-breaker** execution Z=2
- For working aluminium

Rot. DX/RH rot.	D	L	S	Rot.
U140.250.R	25	57,5	10x26	Dx
U140.350.R	35	57,5	10x26	Dx



Z051.302.R



Z059.001.L



Z059.001.R

## PUNTE HS A DUE DIAMETRI PER ALLUMINIO Z=2

### HS DOUBLE DIAMETER SPIRAL BITS FOR ALUMINIUM Z=2

### FOR ALUMINIUM Z=2

ART. U290 - U291

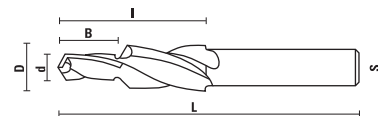

Rot. DX/RH Rot.	d/D	B/l	L	S
U290.055.R	5,5/11,5	12/35	100	10
U290.060.R	6/11,5	12/35	100	10
U290.061.R	6/12	15/35	80	10
U290.062.R	6/14	15/35	80	10
U290.065.R	6,5/13,5	15/35	100	10
U290.070.R	7/13	12/35	100	10
U290.071.R	7/14	12/35	100	10
U290.072.R	7/15	12/35	100	10
U290.080.R	8/15	12/35	100	10
U291.055.R	5,5/11,5	12/35	120	12
U291.060.R	6/12	12/35	100	12
U291.065.R	6,5/11,5	12/35	100	12
U291.066.R	6,5/12	18/45	120	12
U291.067.R	6,5/13,5	12/35	120	12
U291.085.R	8,5/14	12/35	100	12

## CANNOTTI PORTAFRESE PER MACCHINE CON CAMBIO MANUALE

### HOLDING SLEEVES FOR MILLING CUTTER SETS WITH MANUAL INSERTION

ART. YC 320

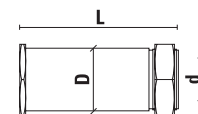

Articolo/Item	D	d	L	Tipo/Type
YC320.160	32	16	100	Manuale/Manual
YC320.220	32	22	100	Manuale/Manual
YC320.270	32	27	100	Manuale/Manual

## CANNOTTI PORTAFRESE PER MACCHINE CON CAMBIO RAPIDO QUICK CHANGE HOLDING SLEEVES FOR MILLING CUTTER SETS

ART. YC 320

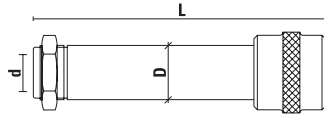

Articolo/Item	D	d	L	Tipo/Type
YC320.900	32	27	135	Rapido/Quick Change

## ANELLI DISTANZIALI/SPACERS

ART. YD 320

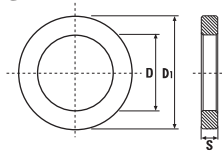

- Da utilizzare con cannotti portafrese per alluminio
- Materiale: acciaio brunito
- Use with holding sleeves for aluminium working
- Burnished

Articolo/Item	D	D1	S	Articolo/Item	D	D1	S
YD320.003	32	45	0,3	YD320.200	32	42	20
YD320.005	32	45	0,5	YD320.300	32	42	30
YD320.010	32	45	1	YD320.400	32	42	40
YD320.020	32	45	2	YD320.500	32	42	50
YD320.050	32	42	5	YD320.600	32	42	60
YD320.100	32	42	10	YD320.800	32	42	80
YD320.150	32	42	15	YD320.900	32	42	90

## GRUPPI PROGRAMMATI PER LAVORARE PROFILATI DI ALLUMINIO SPECIAL UNITS FOR ALUMINIUM-PROFILES

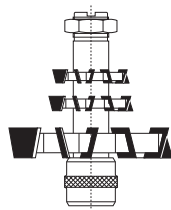

- SI PRODUCONO SU SPECIFICA RICHIESTA
- RICHIEDERE OFFERTA SPECIFICANDO IL TIPO DI PROFILATO E LAVORO DA ESEGUIRE
- PRODUCED ON REQUEST
- PLEASE SEND US YOUR INQUIRY WITH TECHNICAL INFORMATION RELATED

Articolo/Item	Descrizione/Description
ART. YG 000	Per profilati/For alu-profiles "ALL. CO"
ART. YG 001	PER PROFILATI "ALCAN"
ART. YG 002	PER PROFILATI "EQUIPE"
ART. YG 003	PER PROFILATI "ESA ALLUMINIO"
ART. YG 004	PER PROFILATI "DOMAL SER. HYDRO ALLUMINIO"
ART. YG 005	PER PROFILATI "INDIVEST / ALPHA"
ART. YG 006	PER PROFILATI "JOINT (legno - alluminio/wood - alu)"
ART. YG 007	PER PROFILATI "KIKAU"
ART. YG 008	PER PROFILATI "METRA"
ART. YG 009	PER PROFILATI "NEW"
ART. YG 010	PER PROFILATI "OCMA"
ART. YG 011	PER PROFILATI "GLOBAL"
ART. YG 012	PER PROFILATI "PANDOLFO - SCHUKO"
ART. YG 013	PER PROFILATI "PASSERINI"
ART. YG 014	PER PROFILATI "RAI - ALLUMINIA"
ART. YG 015	PER PROFILATI "TRAFILERIE EMILIANE"
ART. YG 016	PER PROFILATI "ITAL - PLASTICK"

## FRESE HW A DENTI ALTERNI HW ALTERNATE TOOTH MILLING CUTTERS

ART. YF 060÷YF120

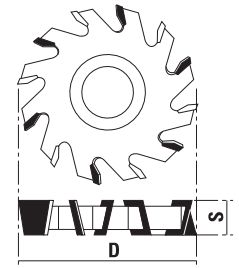

Le frese con denti alterni offrono una migliore capacità di taglio rispetto alle frese con taglienti dritti

Alternate teeth for better quality of cut

Articolo/Item	D	S	F	Z	Articolo/Item	D	S	F	Z
YF060.040	60	4	32	6	YF100.040	100	4	32	10
YF060.050	60	5	32	6	YF100.050	100	5	32	10
YF060.060	60	6	32	6	YF100.060	100	6	32	10
YF060.070	60	7	32	6	YF100.070	100	7	32	10
YF060.080	60	8	32	6	YF100.080	100	8	32	10
YF060.100	60	10	32	6	YF100.100	100	10	32	10
YF060.120	60	12	32	6	YF100.120	100	12	32	10
YF060.140	60	14	32	6	YF100.140	100	14	32	10
YF060.160	60	16	32	6	YF100.160	100	16	32	10
YF070.040	70	4	32	8	YF100.180	100	18	32	10
YF070.050	70	5	32	8	YF100.200	100	20	32	10
YF070.060	70	6	32	8	YF100.250	100	25	32	10
YF070.070	70	7	32	8	YF100.300	100	30	32	10
YF070.080	70	8	32	8	YF114.040	114	4	32	12
YF070.100	70	10	32	8	YF114.050	114	5	32	12
YF070.120	70	12	32	8	YF114.060	114	6	32	12
YF070.140	70	14	32	8	YF114.070	114	7	32	12
YF070.160	70	16	32	8	YF114.080	114	8	32	12
YF080.040	80	4	32	8	YF114.100	114	10	32	12
YF080.050	80	5	32	8	YF114.120	114	12	32	12
YF080.060	80	6	32	8	YF114.140	114	14	32	12
YF080.070	80	7	32	8	YF114.160	114	16	32	12
YF080.080	80	8	32	8	YF114.180	114	18	32	12
YF080.100	80	10	32	8	YF114.200	114	20	32	12
YF080.120	80	12	32	8	YF114.250	114	25	32	12
YF080.140	80	14	32	8	YF114.300	114	30	32	12
YF080.160	80	16	32	8	YF120.040	120	4	32	14
YF080.180	80	18	32	8	YF120.050	120	5	32	14
YF080.200	80	20	32	8	YF120.060	120	6	32	14
YF090.040	90	4	32	8	YF120.070	120	7	32	14
YF090.050	90	5	32	8	YF120.080	120	8	32	14
YF090.060	90	6	32	8	YF120.100	120	10	32	14
YF090.070	90	7	32	8	YF120.120	120	12	32	14
YF090.080	90	8	32	8	YF120.140	120	14	32	14
YF090.100	90	10	32	8	YF120.160	120	16	32	14
YF090.120	90	12	32	8	YF120.180	120	18	32	14
YF090.140	90	14	32	8	YF120.200	120	20	32	14
YF090.160	90	16	32	8	YF120.250	120	25	32	14
YF090.180	90	18	32	8	YF120.300	120	30	32	14
YF090.200	90	20	32	8					

## FRESE HW PER LAVORAZIONE ALUCOBOND® E MATERIALI COMPOSITI DI ALLUMINIO CARBIDE TIPPED MILLING CUTTERS FOR ALUCOBOND® AND ACM

ART. YU120 - YU121

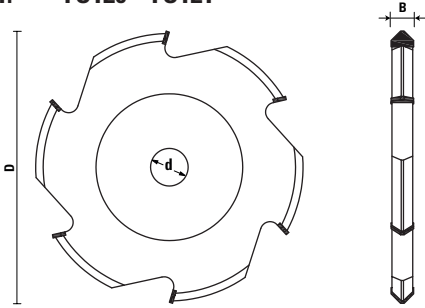

- Appositamente studiata per fresare e piegare pannelli di **ALUCOBOND®**, **ALUPANEL®**, **REYNOBOND®**, **DIBOND®**, **STACBOND®** con angoli a 90° e 135° (a fondo piatto) a scanalature rettangolari, rendendo la piegatura dei pannelli un'operazione semplice e senza il rischio di rottura
- Per macchine sezionatrici verticali e fresatrici
- Tagliante con placchette in HW
- Gamma completa frese per **ALUCOBOND®** a pag. 8.08 (Catalogo generale 19.A)
- Carbide tipped cutting edges
- For routing and folding on **ALUCOBOND®**, **ALUPANEL®**, **REYNOBOND®**, **DIBOND®**, **STACBOND®**
- Especially designed for scoring ACM (aluminium compaund material) with 90° and 135° angles (with flat bottoms) and rectangular groove for foldings up to 180°, thus allowing a simple hand bending operation of the panel without cracking
- For vertical panel saw and milling machine
- Complete range of router bits for ACM at page 8.08 (Catalog 19.A)

Articolo/Item	D	B	d	Z	α	R	D1
YU120.090.R	220	18	30	8	90°	-	3
YU120.135.R	220	18	30	8	135°	-	2
YU121.040.R	219	14	30	8	-	40	-

### I VANTAGGI DELLA TECNICA DA FRESATURA E PIEGATURA:

- Minimo investimento
- Operazione semplice e veloce
- Costi di produzione ridotti per parti modellate di façade, cornici, rivestimenti, bordi di tetti, angoli
- Economia di prodotto
- Piegatura senza tensione quindi senza rischio di deformazione negli angoli

### ADVANTAGES OF FOLDING AND ROUTING TECHNIQUE:

- Minimum investment
- Simple operating technique
- Low-cost manufacture of shaped parts like façade elements, frames, fascia claddings and roof edgings, corner pieces
- Good economy
- Tension-free folding, therefore no buckling in the corner area

#### YU120.090.R

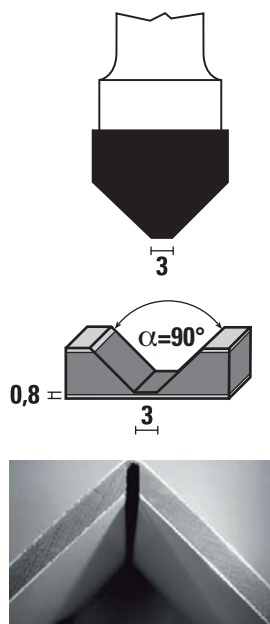

#### YU120.135.R

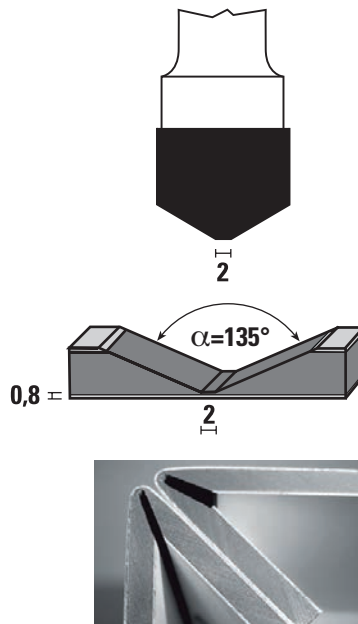

#### YU121.040.R

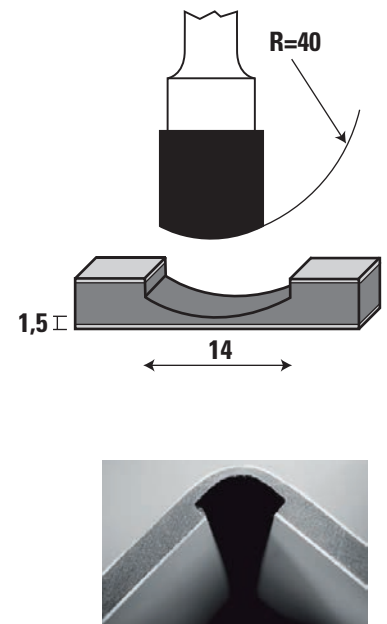

## FRESE HW INTEGRALI A TAGLIENTI DIRITTI PER LAVORAZIONE ALUCOBOND® E MATERIALI COMPOSITI DI ALLUMINIO VHW STRAIGHT BITS FOR WORKING ALUCOBOND® AND ACM

ART. U108

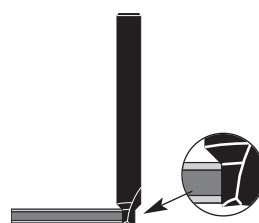

- Ideale per ottenere una finitura priva di sbavature di lavorazione
- Appositamente studiata per fresare pannelli di **ALUCOBOND®**, **ALUPANEL®**, **REYNOBOND®**, **DIBOND®** e **STACBOND®**
- Ideal for obtaining a smudge-free finish
- For routing on **ALUCOBOND®**, **ALUPANEL®**, **REYNOBOND®**, **DIBOND®** and **STACBOND®**

Articolo/Item	D	B	L	S	Z	Rot.
U108.050.R	5	4	70	8	2+1	Dx/Rh

## LAME CIRCOLARI HW PER SEGHE PORTATILI HW SAWBLADES FOR PORTABLE MACHINES

ART. AB

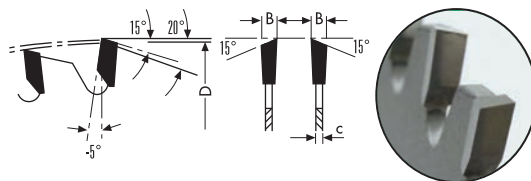

Articolo/Item	D	d	B/c	Z	Fori trasc./Pin holes
AB216.02430	216	30	3,0/2,0	24	
AB216.04830	216	30	3,0/2,0	48	
AB216.06030	216	30	3,0/2,0	60	
AB260.06030	260	30	2,5/1,8	60	PH02
AB305.06030	305	30	3,2/2,2	60	

### CARATTERISTICHE DEI DENTI TEETH FEATURES

- WZ (ATB) dente alternato  
*alternate top bevel teeth*
- Angolo 5° negativo/5° *negative hook angle*
- Qualità HW/HW grade: KCR10

### MATERIALI / MATERIALS

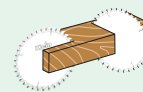

Legno duro/Hardwood

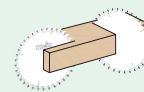

Legno tenero/Softwood

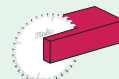

Plastica/Plastic



Legno con chiodi  
Wood with nails

### MACCHINE / MACHINES



Troncatrici  
Power mitre saws



Sega portatile  
Portable saw



Sega a nastro  
Panel saw

### INFORMAZIONI / INFORMATION

- Lame da taglio HW a taglio fine  
*Fine cut HW sawblades*
- Fori trascinamento/Pin holes:  
PH02=2/7/42 + 2/9,5/46,5 + 2/10/60

## LAME CIRCOLARI HW PER SEGHE PORTATILI HW SAWBLADES FOR PORTABLE MACHINES

ART. AL

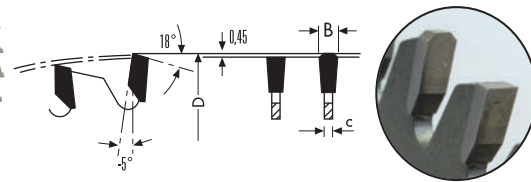

Articolo/Item	D	d	B/c	Z	Fori trasc./Pin holes
AL160.02416	160	16	2,6/1,6	40	
AL160.02420	160	20	2,6/1,6	40	2/6/32
AL160.05620	160	20	2,2/1,6	56	2/6/32
AL180.02420	180	20	2,6/1,6	48	2/6/32
AL190.03020	190	20	2,6/1,6	54	2/6/32
AL190.03030	190	30	2,6/1,6	54	2/7/42
AL210.03430	210	30	2,6/1,6	54	
AL216.06030	216	30	3,0/2,0	64	
AL220.03430	220	30	3,0/2,0	64	2/7/42

### CARATTERISTICHE DEI DENTI TEETH FEATURES

- FZ/TR (TCG) dente trapezio/piano  
*triple chip teeth*
- Angolo 5° negativo/5° *negative hook angle*
- Qualità HW/HW grade: KCR10

### MATERIALI / MATERIALS

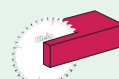

Plastica/Plastic

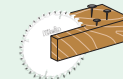

Legno con chiodi  
Wood with nails

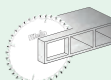

Profili Alluminio  
Aluminium profiles

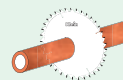

Rame/Copper

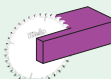

Solid surface

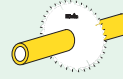

Ottone/Brass

### MACCHINE / MACHINES



Troncatrici  
Power mitre saws



Sega portatile  
Portable saw



Sega a nastro  
Panel saw

### INFORMAZIONI / INFORMATION

- Lame da taglio HW a taglio fine  
*Fine cut HW sawblades*



## LAME PROFESSIONALI A SPESSORE SOTTILE / EXTRA THIN KERF PROFESSIONAL SAWBLADES



Dentelli in micrograna di metallo duro ad alte prestazioni, resistenti alle sollecitazioni e alla corrosione, migliorano la qualità del taglio e aumentano la durata di vita della lama.  
*Fine hardmetal powder grain creates compact and sturdy carbide teeth that reduce abrasion, improve quality of the cut and increase life of the blade.*



Lo speciale design extra-sottile della lama consente tagli più veloci, riducendo lo sforzo delle seghe portatili e a batteria, assicurando una velocità di avanzamento più rapida.  
*The special extra-thin kerf design allows fast and effortless cuts on cordless and portable saw, ensuring a higher feed rate and faster work progress.*



I tagli di silenziatura incisi al laser riducono le vibrazioni, aumentano la silenziosità e prevengono lo sbandieramento per una perfetta qualità di taglio.  
*Our laser-cut silent slots reduce noise, prevent sideways movement and improve cutting quality. The laser-cut expansion slots prevent stress and warping.*



L'acciaio utilizzato per i corpi lama è di qualità superiore e temprato (HRC 46), viene tagliato al laser per garantire una maggiore precisione, minori sollecitazioni e un migliore bilanciamento durante la lavorazione.  
*Our superior quality steel of the sawblade bodies is hardened up to HRC 46 and cut by laser to guarantee higher precision, less stress and better balancing.*



## LAME PROFESSIONALI A SPESSORE SOTTILE EXTRA THIN KERF PROFESSIONAL SAWBLADES

ART. AT

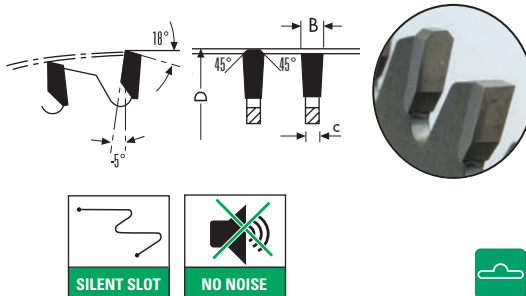

Articolo/Item	D	d (riduzione/ reductions)	B/c	$\alpha$	Z	Fori trasc./Pin holes
AT160.04820	160	20 (16)	1,8/1,3	-5°	48	2/6/32
AT190.05430	190	30 (1"-20)	1,8/1,3	-5°	54	PH02
AT216.06430	216	30 (1"-20)	2,3/1,6	-5°	64	PH02



### CARATTERISTICHE DEI DENTI TEETH FEATURES

- FZ/TR (TCG) dente piatto trapezoidale  
triple chip teeth trapezoidal
- Qualità HW/HW grade: KCR10

### MATERIALI / MATERIALS



Alluminio  
Aluminium



Plastica  
Plastic



Melaminico  
Melamine



Laminato  
Laminate

### MACCHINE / MACHINES



Troncatrici  
Power mitre saws



Sega portatile  
Portable saw



Batteria  
Cordless

### INFORMAZIONI / INFORMATION

- Dentelli in micrograna di metallo duro ad alte prestazioni, resistenti alle sollecitazioni e alla corrosione, migliorano la qualità del taglio e aumentano la durata di vita della lama.  
*The special extra-thin kerf design allows fast and effortless cuts on cordless and portable saw, ensuring a higher feed rate and faster work progress.*
- Fori trasc./Pin holes:  
**PH02=2/7/42 + 2/9,5/46,5 + 2/10/60**

Xtra<sup>®</sup>  
cut

LA NUOVA GENERAZIONE  
DI LAME INDUSTRIALI  
**THE NEXT GENERATION OF  
INDUSTRIAL SAWBLADES**



**LE FESSURE DI ESPANSIONE** tagliate al laser consentono la dispersione del calore e migliorano la stabilità della lama / **LASER CUT EXPANSION SLOTS** allow heat dispersion and improve blade stability.

**LAMA IN ACCIAIO TAGLIATA AL LASER** con acciaio tedesco per garantire grandi tolleranze e stabilità / **LASER CUT STEEL BLADE** with German steel to provide great tolerances and stability

**PUNTI DI CARBURO INDUSTRIALE A MICROGRADO** prodotti da Ceratizit per offrire un bordo più affilato e una maggiore durata di taglio / **MICROGRAIN INDUSTRIAL CARBIDE TIPS** made by Ceratizit to provide sharper edge and longer cutting life

**ANELLO DI TENSIONE E BILANCIAMENTO** per garantire massime prestazioni di taglio, concentricità e planarità della lama / **TENSIONING RING AND BALANCING** to guarantee highest cutting performance, concentricity and flatness of the blade

**OPERAZIONE DI BRASATURA TRI-METALLICA** (lega+rame+lega) per le migliori prestazioni e la massima resistenza alle sollecitazioni / **TRI-METAL BRAZING OPERATION** (alloy+copper+alloy) for best performance and maximum resistance to stress

**TAGLI SILENZIATURA RIEMPITI DI RESINA** appositamente studiate per migliorare la finitura e ridurre il rumore / **ANTI-VIBRATION SLOTS FILLED WITH RESIN** especially designed to improve finishing and reduce noise

MADE IN ITALY  
HW-FZ/TR WOOD  
FCT300.09630

SAFETY RECOMMENDATION  
NO VIBRATION  
NO NOISE

300x32/22x30+PH2 Z=96 TP  
N/MAK 6000

WATCH THE DEMO



## LAME CIRCOLARI HW PER ALLUMINIO HW POSITIVE SAWBLADES FOR ALUMINIUM

ART. LA

# Xtra<sup>®</sup> cut

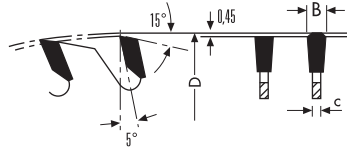

Articolo/Item	D	d	B/c	Z	Fori trasc./Pin holes
LA200.06430	200	30	3,2/2,5	64	2/11/63
LA200.06432	200	32	3,2/2,5	64	2/11/63
LA250.06030	250	30	3,4/2,6	60	2/11/63
LA250.06032	250	32	3,4/2,6	60	2/11/63
LA250.08030	250	30	3,4/2,6	80	2/11/63
LA250.08032	250	32	3,4/2,6	80	2/11/63
LA300.07230	300	30	3,4/2,6	72	2/11/63
LA300.07232	300	32	3,4/2,6	72	2/11/63
LA300.08430	300	30	3,4/2,6	84	2/11/63
LA300.08432	300	32	3,4/2,6	84	2/11/63
LA300.09630	300	30	3,4/2,6	96	2/11/63
LA300.09632	300	32	3,4/2,6	96	2/11/63
LA350.08430	350	30	3,4/2,6	84	2/11/63
LA350.08432	350	32	3,4/2,6	84	2/11/63
LA350.09630	350	30	3,4/2,6	96	2/11/63
LA350.09632	350	32	3,4/2,6	96	2/11/63
LA350.10830	350	30	3,4/2,6	108	2/11/63
LA350.10832	350	32	3,4/2,6	108	2/11/63
LA400.09630	400	30	4,0/3,2	96	2/11/63
LA400.09632	400	32	4,0/3,2	96	2/11/63
LA400.09732	400	32	3,6/3,0	96	2/11/63
LA400.12030	400	30	4,0/3,2	120	2/11/63
LA400.12032	400	32	4,0/3,2	120	2/11/63
LA420.09630	420	30	4,0/3,2	96	2/11/63
LA420.09632	420	32	4,0/3,2	96	2/11/63
LA450.07330	450	30	3,8/3,2	72	2/11/63
LA450.07332	450	32	3,8/3,2	72	2/11/63
LA450.09630	450	30	4,0/3,2	96	2/11/63
LA450.09632	450	32	4,0/3,2	96	2/11/63
LA450.09732	450	32	3,8/3,2	96	2/11/63
LA450.10830	450	30	4,0/3,2	108	2/11/63
LA450.10832	450	32	4,0/3,2	108	2/11/63
LA500.09730	500	30	4,0/3,2	96	2/11/63
LA500.09732	500	32	4,0/3,2	96	2/11/63
LA500.12030	500	30	4,6/3,6	120	2/11/63
LA500.12032	500	32	4,6/3,6	120	2/11/63
LA500.12130	500	30	4,0/3,2	120	2/11/63
LA500.12132	500	32	4,0/3,2	120	2/11/63
LA550.12130	550	30	4,2/3,6	120	2/11/63
LA550.12132	550	32	4,2/3,6	120	2/11/63
LA550.14030	550	30	4,6/3,6	140	2/11/63
LA550.14130	550	30	4,2/3,6	140	2/11/63
LA550.14132	550	32	4,2/3,6	140	2/11/63
LA600.14030	600	30	4,6/3,6	140	
LA600.14032	600	32	4,6/3,6	140	
LA600.14040	600	40	4,6/3,6	140	
LA620.14040	620	40	4,4/3,8	140	2/15/80
LA650.14040	650	40	5,0/4,0	140	

### CARATTERISTICHE DEI DENTI TEETH FEATURES

- FZ/TR (TCG) dente trapezio/piano  
triple chip teeth
- Angolo 5° positivo/5° positive hook angle
- Qualità HW/HW grade: KCR10

### MATERIALI / MATERIALS

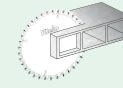

Profili Alluminio  
Aluminium profiles

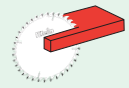

PVC

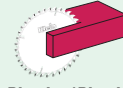

Plastica/Plastic



Plexiglass



Rame/Copper

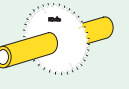

Ottone/Brass

### MACCHINE / MACHINES



Troncatrici  
Power mitre saws



Banco sega  
Table saw



Sega a nastro  
Panel saw



Segatrici per alluminio  
Aluminium sawing machines

### INFORMAZIONI / INFORMATION

Numero di giri consigliati in funzione del diametro  
RPM suggested referred to the blade diameter

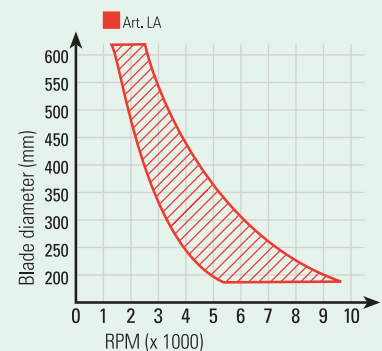

## LAME CIRCOLARI HW PER ALLUMINIO HW NEGATIVE SAWBLADES FOR ALUMINIUM

ART. LB

# Xtra cut®

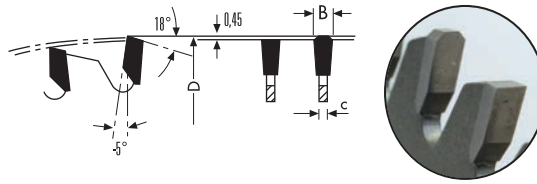

Articolo/Item	D	d	B/c	Z	Fori trasc./Pin holes
LB200.06430	200	30	3,2/2,5	64	2/11/63
LB200.06432	200	32	3,2/2,5	64	2/11/63
LB250.06030	250	30	3,4/2,6	60	2/11/63
LB250.08030	250	30	3,4/2,6	80	2/11/63
LB250.08032	250	32	3,4/2,6	80	2/11/63
LB300.07230	300	30	3,4/2,6	72	2/11/63
LB300.08430	300	30	3,4/2,6	84	2/11/63
LB300.08432	300	32	3,4/2,6	84	2/11/63
LB300.09630	300	30	3,4/2,6	96	2/11/63
LB300.09632	300	32	3,4/2,6	96	2/11/63
LB350.08430	350	30	3,4/2,6	84	2/11/63
LB350.08432	350	32	3,4/2,6	84	2/11/63
LB350.09630	350	30	3,4/2,6	96	2/11/63
LB350.09632	350	32	3,4/2,6	96	2/11/63
LB350.10830	350	30	3,4/2,6	108	2/11/63
LB350.10832	350	32	3,4/2,6	108	2/11/63
LB400.09630	400	30	4,0/3,2	96	2/11/63
LB400.09632	400	32	4,0/3,2	96	2/11/63
LB400.12030	400	30	4,0/3,2	120	2/11/63
LB400.12032	400	32	4,0/3,2	120	2/11/63
LB450.09630	450	30	4,0/3,2	96	2/11/63
LB450.09632	450	32	4,0/3,2	96	2/11/63
LB450.10830	450	30	4,0/3,2	108	2/11/63
LB450.10832	450	32	4,0/3,2	108	2/11/63
LB500.12030	500	30	4,6/3,6	120	2/11/63
LB500.12032	500	32	4,6/3,6	120	2/11/63
LB500.12130	500	30	4,0/3,2	120	2/11/63
LB500.12132	500	32	4,0/3,2	120	2/11/63
LB550.14030	550	30	4,6/3,6	140	2/11/63
LB600.14030	600	30	4,6/3,6	140	2/11/63
LB650.14030	650	30	5,0/4,0	140	2/11/63

### CARATTERISTICHE DEI DENTI TEETH FEATURES

- FZ/TR (TCG) dente trapezio/piano  
triple chip teeth
- Angolo 5° negativo/5° negative hook angle
- Qualità HW/HW grade: KCR10

### MATERIALI / MATERIALS

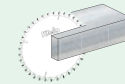

Alluminio  
Solid Aluminium

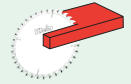

PVC

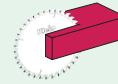

Plastica/Plastic

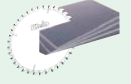

Plexiglass

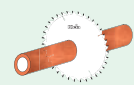

Rame/Copper

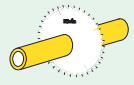

Ottone/Brass

### MACCHINE / MACHINES



Troncatrici  
Power mitre saws



Banco sega  
Table saw



Sega a nastro  
Panel saw



Segatrici per alluminio  
Aluminium sawing machines

### INFORMAZIONI / INFORMATION

Numero di firi consigliati in funzione del diametro  
RPM suggested referred to the blade diameter

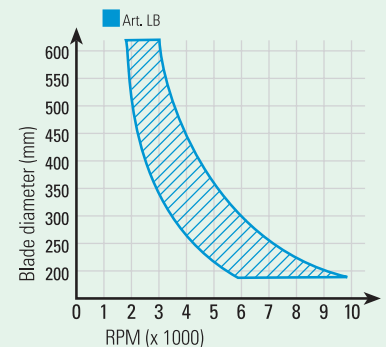

## LAME CIRCOLARI HW PER PVC HW SAWBLADES FOR PVC

ART. LE



# Xtra cut

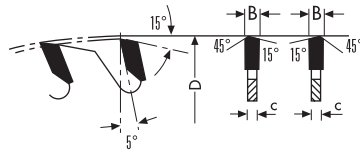

Articolo/Item	D	d	B/c	Z	Fori trasc./Pin holes
LE200.06430	200	30	3,0/2,5	64	
LE250.08030	250	30	3,0/2,5	80	PH01
LE300.09630	300	30	3,0/2,5	96	PH01
LE350.10830	350	30	3,2/2,5	108	PH01
LE400.12030	400	30	3,6/3,0	120	2/11/63
LE450.12030	450	30	3,8/3,2	120	2/11/63
LE500.12030	500	30	4,0/3,2	120	2/11/63
LE550.14030	550	30	4,2/3,5	140	2/11/63
LE600.14030	600	30	4,2/3,5	140	2/11/63

### CARATTERISTICHE DEI DENTI TEETH FEATURES

- WZ/FA dente alternato smussato  
*alternate-trap, teeth*
- Qualità HW/HW grade: KCR05+ (K01-C4)

### MATERIALI / MATERIALS

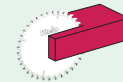

Plastica/Plastic

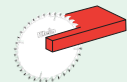

PVC

### MACCHINE / MACHINES



Troncatrici  
Power mitre saws



Banco sega  
Table saw



Segha a nastro  
Panel saw

### INFORMAZIONI / INFORMATION

- Specialmente indicate per il taglio di PVC e materiali plastici grazie allo spessore più sottile.  
*Especially made for cutting PVC and thin plastic material thanks to the thinner kerf*
- Fori trascinamento/Pin holes:  
PH01=2/10/60

## LAME CIRCOLARI DI PRECISIONE HW EXTRACUT HW CIRCULAR SAWBLADES FOR BILAMINATED PANELS

ART. FCT



# Xtra cut

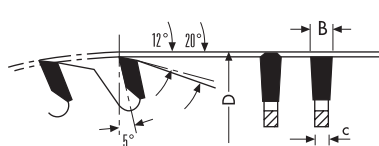

Articolo/Item	D	d	B/c	Z	Fori trasc./Pin holes
FCT250.06030	250	30	3,2/2,2	60	PH02
FCT250.08030	250	30	3,2/2,2	80	PH02
FCT300.07230	300	30	3,2/2,2	72	PH02
FCT300.09630	300	30	3,2/2,2	96	PH02
FCT350.08430	350	30	3,5/2,5	84	PH02
FCT350.11230	350	30	3,5/2,5	112	PH02

### CARATTERISTICHE DEI DENTI TEETH FEATURES

- FZ/TR (TCG) dente trapezio/piano  
*triple chip teeth*
- Qualità HW/HW grade: KCR10

### MATERIALI / MATERIALS

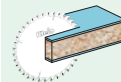

Laminato su due lati  
Double side laminated



Impiallacciati su due lati  
Double side veneer

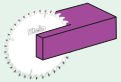

Solid surface

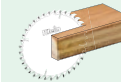

Compensato  
Plywood



Truciolato  
Chipboard

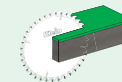

HPL

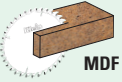

MDF

### MACCHINE / MACHINES



Troncatrici  
Power mitre saws



Banco sega  
Table saw



Segha a nastro  
Panel saw

### INFORMAZIONI / INFORMATION

- Ideale per lavorazioni ALUCOBOND®  
*Ideal also for working ALUCOBOND®, a composite panel consisting of two aluminium cover sheets and a plastic core which can be polyethylene (PE) or mineral core (ALUCOBOND® Plus - A2)*
- Fori trascinamento/Pin holes:  
PH02=2/7/42 + 2/9,5/46,5 + 2/10/60

## LAME CIRCOLARI DI PRECISIONE HW HW CIRCULAR SAWBLADES FOR BILAMINATED PANELS

ART. FCS

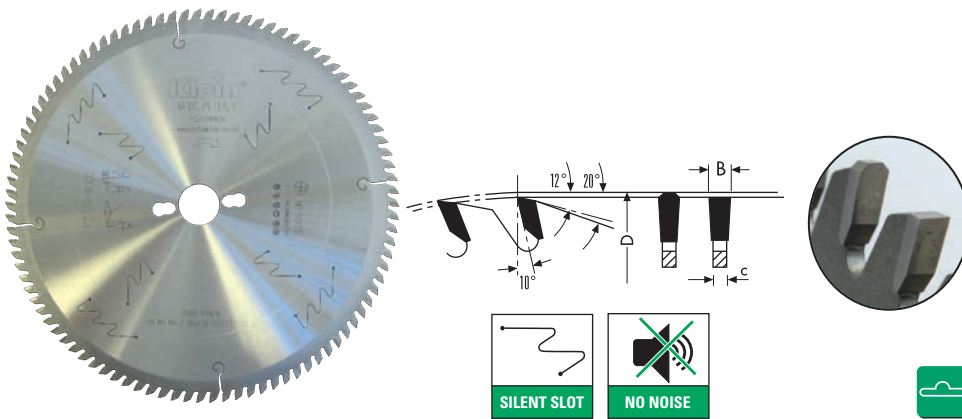

Articolo/Item	D	d	B/c	Z	Fori trasc./Pin holes
FCS250.06030	250	30	3,2/2,2	60	PH02
FCS250.08030	250	30	3,2/2,2	80	PH02
FCS300.07230	300	30	3,2/2,2	72	PH02
FCS300.09630	300	30	3,2/2,2	96	PH02
FCS300.09635	300	35	3,2/2,2	96	PH02
FCS350.08430	350	30	3,5/2,5	84	PH02
FCS350.11230	350	30	3,5/2,5	112	PH02

### CARATTERISTICHE DEI DENTI TEETH FEATURES

- FZ/TR (TCG) dente trapezio/piano  
*triple chip teeth*
- Qualità HW/HW grade: KCR05+ (K01-C4)

### MATERIALI / MATERIALS

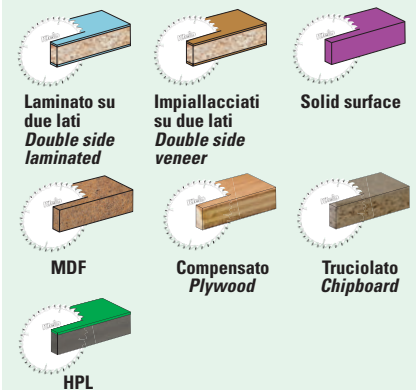

### MACCHINE / MACHINES



### INFORMAZIONI / INFORMATION

- Ideale anche per lavorazione  
*Ideal also for working ALUCOBOND®*
- Fori trascinamento/Pin holes:  
PH02=2/7/42 + 2/9,5/46,5 + 2/10/60

## LAME CIRCOLARI DI PRECISIONE HW HW TRIMMING AND SIZING SAWBLADES

ART. FB

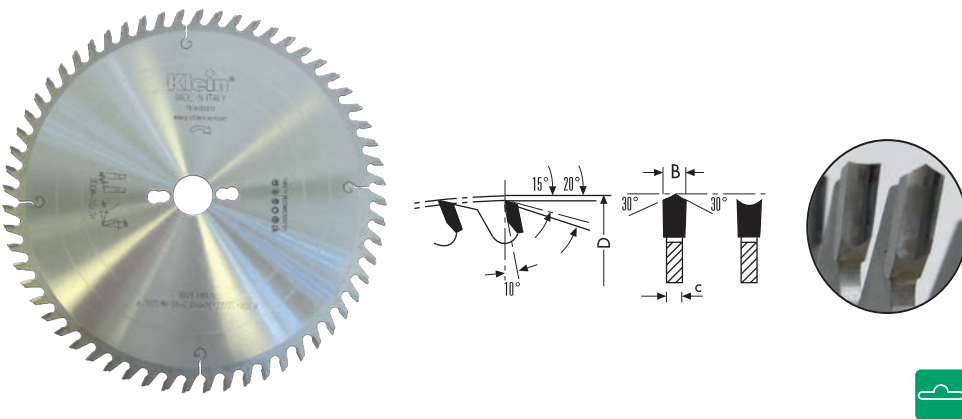

Articolo/Item	D	d	B/c	Z	Fori trasc./Pin holes
FB220.04230	220	30	3,2/2,2	42	
FB253.04830	250	30	3,2/2,2	48	PH02
FB303.06030	300	30	3,2/2,2	60	PH02
FB350.07230	350	30	3,5/2,5	72	PH02

### CARATTERISTICHE DEI DENTI TEETH FEATURES

- HZ/DZ Dente concavo e punta  
*inverted "V" and hollow ground teeth*
- Qualità HW/HW grade: KCR05+ (K01-C4)

### MATERIALI / MATERIALS

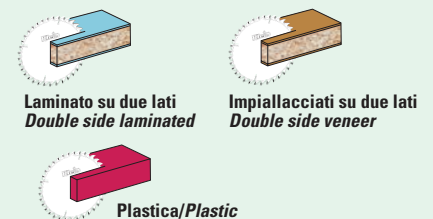

### MACCHINE / MACHINES



### INFORMAZIONI / INFORMATION

- Buona finitura, lunga durata di taglio  
*Extra finish and long cutting life*
- Possono lavorare anche senza l'ausilio dell'incisore  
*These sawblades can work without the help of conical scoring saw blades*
- Fori trascinamento/Pin holes:  
PH02=2/7/42 + 2/9,5/46,5 + 2/10/60

## LAME CIRCOLARI HW "QUATTRO" O "DRY" HW "DRY" OR "QUATTRO" SAWBLADES

ART. LZ

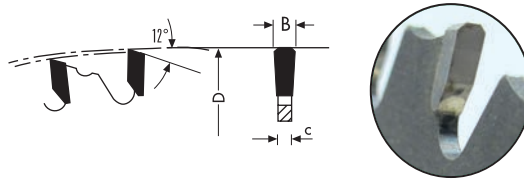

Articolo/Item	D	d	B/c	Z	Fori trasc./Pin holes
LZ150.03020	150	20	2,2/1,6	30	
LZ160.03020	160	20	2,2/1,6	30	
LZ180.03430	180	30	2,2/1,6	30	
LZ190.03830	190	30	2,2/1,6	38	
LZ200.04030	200	30	2,2/1,6	40	
LZ210.04030	210	30	2,2/1,6	40	
LZ230.04430	230	30	2,2/1,6	40	2/7/42
LZ250.04820	250	20	2,4/1,8	48	2/7/42
LZ250.04830	250	30	2,4/1,8	48	2/7/42
LZ300.06026	300	25,4	2,4/1,8	60	2/7/42+2/10/60
LZ300.06030	300	30	2,4/1,8	60	2/7/42+2/10/60
LZ305.08026	305	25,4	2,4/1,8	80	2/7/42+2/10/60
LZ350.08030	350	30	2,6/2,0	70	2/7/42+2/10/60
LZ355.08026	355	25,4	2,6/2,0	80	2/7/42+2/10/60
LZ400.08430	400	30	3,0/2,0	84	2/10/60

## LAME CIRCOLARI HW PER SOLID SURFACE HW SAWBLADES FOR "SOLID SURFACE" AND CHIPBOARD PANELS

ART. MES

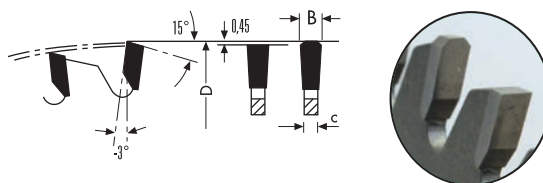

Articolo/Item	D	d	B/c	Z	Fori trasc./Pin holes
MES250.06030	250	30	3,2/2,5	60	PH02
MES250.08030	250	30	3,2/2,5	80	PH02
MES300.08430	300	30	3,2/2,5	84	PH02
MES300.09630	300	30	3,2/2,5	96	PH02
MES350.11230	350	30	3,2/2,5	112	PH02

### CARATTERISTICHE DEI DENTI TEETH FEATURES

- TR dente piatto smussato ai lati  
*special form of teeth*
- Qualità HW/HW grade: SMX (P20 - P25 - C6)

### MATERIALI / MATERIALS

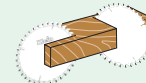

Legno duro  
Hardwood

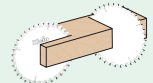

Legno tenero  
Softwood

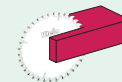

Plastica/Plastic



Acciaio e materiale ferroso  
Steel and ferrous material

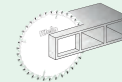

Profili Alluminio  
Aluminium profiles

### MACCHINE / MACHINES



Segha portatile  
Portable saw



Troncatrici  
Power mitre saws



Banco sega  
Table saw

### INFORMAZIONI / INFORMATION

- "QUATTRO" come i gruppi di materiali che può tagliare: metalli ferrosi e non ferrosi, legno duro e tenero lungo e traversa vena, materie plastiche, pannelli di materiali composti  
*"QUATTRO" like the four kind of material that can be cut with these sawblades: for cutting wood, ferrous and non-ferrous material, plastic and compound materials, composite panels...*

### CARATTERISTICHE DEI DENTI TEETH FEATURES

- FZ/TR (TCG) dente trapezio/piano  
*triple chip teeth*
- Angolo 3° negativo/3° negative hook angle
- Qualità HW/HW grade: KCR05+ (K01-C4)

### MATERIALI / MATERIALS

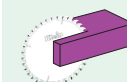

Solid surface

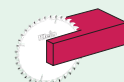

Plastica/Plastic

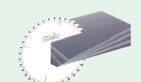

Plexiglass



Truciolato  
Chipboard

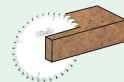

MDF

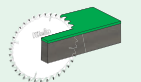

HPL

### MACCHINE / MACHINES



Troncatrici  
Power mitre saws



Banco sega  
Table saw



Segha a nastro  
Panel saw

### INFORMAZIONI / INFORMATION

- Per taglio con perfetta finitura senza rigature e fusione del materiale / *High finishing grade, no scratch, no risk of material melting*
- Fori trascinamento/Pin holes:  
PH02=2/7/42 + 2/9,5/46,5 + 2/10/60

## LAME CIRCOLARI HW PER PLEXIGLASS HW SAWBLADES FOR PVC AND PLEXIGLASS

ART. MGS

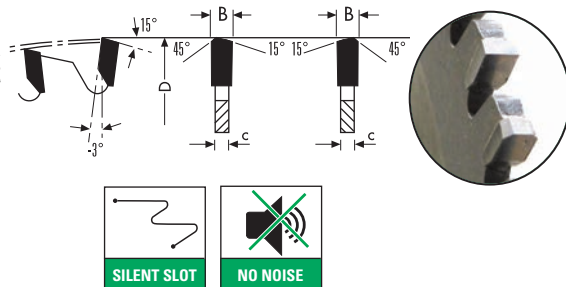

Articolo/Item	D	d	B/c	Z	Fori trasc./Pin holes
MGS250.08030	250	30	2,6/2,0	80	PH02
MGS300.08430	300	30	2,6/2,0	84	PH02
MGS300.09630	300	30	2,6/2,0	96	PH02

### CARATTERISTICHE DEI DENTI TEETH FEATURES

- WZ/FA dente alternato smussato  
*alternate-trap, teeth*
- Angolo 3° negativo/3° negative hook angle
- Qualità HW/HW grade: KCR05+ (K01-C4)

### MATERIALI / MATERIALS

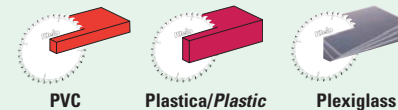

### MACCHINE / MACHINES



### INFORMAZIONI / INFORMATION

- Fori trascinamento/Pin holes:  
PH02=2/7/42 + 2/9,5/46,5 + 2/10/60

## LAME CIRCOLARI IN PKD PER TAGLIO MATERIALI ABRASIVI DP SAWBLADES FOR CUTTING ABRASIVE MATERIALS

ART. XGE

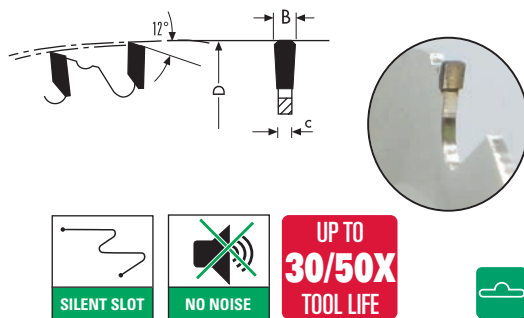

Articolo/Item	D	d	B/c	Z	Fori trasc./Pin holes
XGE160.10420	160	20	2,4/1,6	4	2/6/32
XGE160.10820	160	20	2,4/1,6	8	2/6/32
XGE190.10420	190	20	2,4/1,6	4	2/6/32
XGE200.10430	200	30	2,4/1,6	4	2/7/42
XGE200.10830	200	30	2,4/1,6	8	2/7/42
XGE216.10830	216	30	2,4/1,6	8	-
XGE230.10630	230	30	2,4/1,6	6	2/7/42
XGE250.10630	250	30	2,4/1,6	6	PH02
XGE250.11230	250	30	2,4/1,6	12	PH02
XGE300.11230	300	30	2,4/1,6	12	PH02
XGE300.12030	300	30	2,4/1,6	20	PH02

### CARATTERISTICHE DEI DENTI TEETH FEATURES

- ente piatto in PKD / DP flat teeth
- Altezza placchetta PKD = 3,5 mm  
DP tooth height 3,5 mm

### MATERIALI / MATERIALS

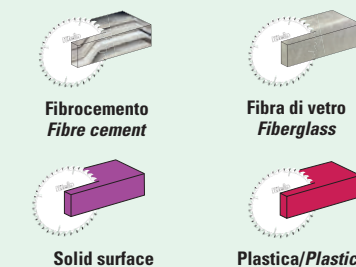

### MACCHINE / MACHINES



### INFORMAZIONI / INFORMATION

- Fori trascinamento/Pin holes:  
PH02=2/7/42 + 2/9,5/46,5 + 2/10/60



## PRE SET P368LR

Il **Preset P368LR** è uno strumento di precisione, di **semplice e veloce utilizzo**, studiato appositamente per soddisfare le esigenze di chi opera con macchine CNC. Viene utilizzato nel settore della lavorazione del legno, del metallo e del vetro dove è necessario presetare o registrare gli utensili. Il Preset P368LR **misura sia il raggio/diametro sia l'altezza degli utensili**. Queste misure vengono direttamente impostate in macchina e la produzione può riprendere velocemente.

*The **Preset P368LR** is a precision tool setting instrument, easy and quick to use, especially designed to meet the requirements of the NC machine operators. It is mainly used in the wood, metal and glass working field where there is a constant need to set or adjust the tools. The **Preset P368LR** measures both the radius/diameter and the length/height of the tools. Working with different tool holders or various machines can be possible by setting up to 4 origins. The measures shown in the display can be set directly in the machine and the production quickly starts again.*

Articolo Item	Capacità di misurazione Measuring range
PRE-SET P368LR	H 300 mm - Ø 250 mm
PRE-SET P368LR/HSK63	H 300 mm - Ø 250 mm



**Asse Z**  
Guida di scorrimento con materiale antifrizione.  
**Axis Z**  
Slide guide in anti-friction material.

**Nr. 2 display** con numeri di grandi dimensioni, collegati alla banda magnetica per il rilevamento delle misure sull'asse X e Z.  
**No. 2 displays** with big numbers are connected to the magnetic strips for measurements detection of axis X and Z.



**Asse X**  
Guida di scorrimento a ricircolo di sfere precaricate.  
**Axis X**  
Preloaded recirculating ball-bearing guides.

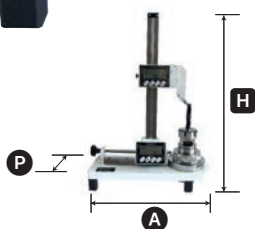

P368	Dimensioni Dimension	Peso Weight	Alimentazione Power
LR	A 410-P 150-H 540 mm	12 kg	2 batterie AA per display (incluse) 2 AA Batteries each display (included)

### IMBALLO/PACKAGING

P368	Dimensioni Dimension	Peso Weight
LR	A 610-P 485-H 210 mm	15,3 kg

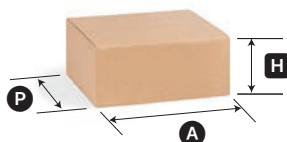

**Misurazione Altezza**  
Il P368 è un presetter molto robusto nato per rendere semplicissima ed accurata la misurazione dell'altezza utensile.  
**Height measurement**  
The P368 is a very solid presetter designed to make tool height measurement very simple and always accurate.



**Misurazione Diametro**  
Il P368 è una struttura solida con movimenti fluidi e precisi. La misurazione del raggio/diametro dell'utensile è sempre precisa.  
**Diameter measurement**  
The P368 has a solid base and provides smooth and accurate linear movements. The tool radius/diameter is always precise.

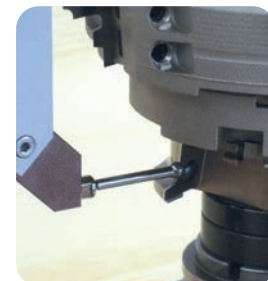

**Tastatore a sfera**  
Utile per la misurazione dei diametri delle frese sagomate (Optional).  
**Spherical feeler** for shaped cutters (optional).

### CARATTERISTICHE TECNICHE

- Ottimo rapporto qualità/prezzo
- Possibilità di memorizzare n° 4 origini macchina
- Riduce notevolmente i tempi per l'attrezzaggio
- Misura tutti i tipi di utensili
- Non richiede il collegamento alla rete elettrica
- Display con numeri di grande dimensione
- Bussola porta coni intercambiabili (ISO, HSK, VDI, alberi porta fresa)

### TECHNICAL FEATURES:

- Excellent price/quality relationship
- Considerable cutback of tooling-up times, no waste of material
- 4 machine origins
- It measures all types of tools
- Battery powered – no need of electrical plug
- Large display easy to read
- One touch conversion mm/inch
- Interchangeable cone holders (ISO, HSK, VDI, arbors)

### Articolo/Item

T. SFERA-P368

### BUSSOLE DI RICAMBIO

I **Preset P368LR** vengono forniti con bussola porta-cono (ISO30, ISO40, ISO50) a scelta. Il **Preset P368LR/HSK63F** è fornito con bussola per HSK63F inclusa. Altre bussole possono essere acquistate anche in seguito.

### SPARE CONE HOLDERS

The preset P368LR is supplied with a cone-holder (ISO30, ISO40, ISO50) on your choice. The Preset P368LR/HSK63F is supplied with an HSK63F cone holder included. Other cone-holders can also be purchased later.



Articolo/Item	Descrizione/Description
PRE-SET B.ISO 30	per coni/for tool holders ISO 30
PRE-SET B.ISO 40	per coni/for tool holders ISO 40
PRE-SET B.ISO 50	per coni/for tool holders ISO 50
PRE-SET B.HSK 63F	per coni/for tool holders HSK 63F/D/B
PRE-SET B.HSK 63A	per coni/for tool holders HSK 63A/C/E
PRE-SET B.HSK 80A	per coni/for tool holders HSK 80
PRE-SET B.30x130	albero/with arbor L=130, frese/tools with bore d= 30
PRE-SET B.30x300	albero/with arbor L=300, frese/tools with bore d= 30
PRE-SET B.35x130	albero/with arbor L=130, pfrese/tools with bore d= 35
PRE-SET B.35x300	albero/with arbor L=300, frese/tools with bore d= 35
PRE-SET B.40x130	albero/with arbor L=130, frese/tools with bore d= 40
PRE-SET B.40x300	albero/with arbor L=300, frese/tools with bore d= 40
PRE-SET B.50x130	albero/with arbor L=130, frese/tools with bore d= 50
PRE-SET B.50x300	albero/with arbor L=300, frese/tools with bore d= 50

## CALIBRI/GAUGES

Le moderne tecnologie di produzione nella lavorazione del pannello hanno reso indispensabile l'utilizzo di strumenti di misura appropriati e precisi che permettano di ottenere un elevato standard qualitativo. La linea di calibri che riportiamo di seguito è stata studiata per soddisfare tutte le esigenze di misurazione nella lavorazione del **legno** ed è comunemente utilizzata anche nella lavorazione dell'**alluminio**, del **vetro** e delle **lamiere**. Tutti i calibri sono costruiti in acciaio cromato con graduazione incisa al laser ed hanno una **RISOLUZIONE** di **0,1 mm**.

*Modern panel working production technologies have made indispensable the use of appropriate measuring instruments sufficiently precise to achieve high quality standards. The line of gauges shown below has been designed to meet all woodworking measurement needs and these gauges are commonly used even in the working of **aluminium**, **glass** and **sheet metals**.*

*All the gauges are made of chromium-plate steel with inscribed scale and coloured black; **PRECISION** of 0,1 mm.*

## CALIBRO PER MISURE LINEARI/GAUGE FOR LINEAR MEASUREMENTS

ART. C.LIN

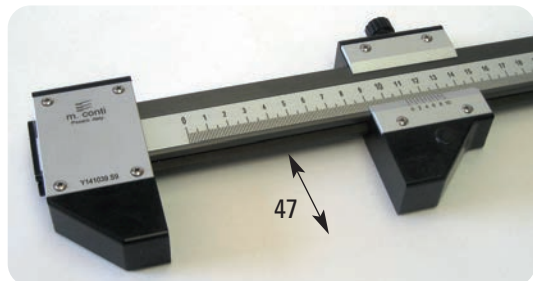

Adatto nella misurazione delle dimensioni di larghezza e lunghezza dei pannelli in legno e suoi derivati.

*Suitable for measuring wood panel widths and lengths, but also for glass, aluminium profiles and sheet metal.*

Articolo/Item	Dimensioni/Dimension	Articolo/Item	Dimensioni/Dimension	Articolo/Item	Dimensioni/Dimension
C.LIN.0500	0÷500	C.LIN.1500	0÷1500	C.LIN.2500	0÷2500
C.LIN.0750	0÷750	C.LIN.2000	0÷2000	C.LIN.3200	0÷3200
C.LIN.1000	0÷1000				

## CALIBRO PER MISURE INTERNE-ESTERNE/GAUGE FOR INSIDE/OUTSIDE MEASURING

ART. C.LIE

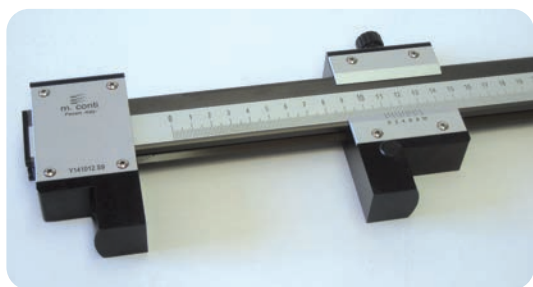

Adatto per la misurazione di grandi fori (min. 50 mm) e/o aperture su pannelli e infissi in legno e suoi derivati. Nelle misurazioni interne va aggiunto il valore di 50 mm.

*Suitable for measuring big dimension openings (min. 50 mm) on wood panels and frames. For inside measurings mm 50 is to be added.*

Articolo/Item	Dimensioni/Dimension	Articolo/Item	Dimensioni/Dimension	Articolo/Item	Dimensioni/Dimension
C.LIE0500	0÷500	C.LIE1500	0÷1500	C.LIE2500	0÷2500
C.LIE0750	0÷750	C.LIE2000	0÷2000	C.LIE3200	0÷3200
C.LIE1000	0÷1000				

## ANGOLFAST Il giusto strumento per la misurazione degli angoli/The right instruments for measuring angles.

Angolfast è costruito in alluminio anodizzato. Risulta quindi robusto ma nello stesso tempo leggero e maneggevole. È dotato di livella in plastica antiurto ed è capace di misurare angoli interni compresi fra 20° e 135°.

*Angolfast is made of anodized aluminium, so it is very sturdy but at the same time light and easy to use. It features a shockproof spirit-level and can measure inner angles between 20-135°.*



**PRECISO, ROBUSTO, VERSATILE, LEGGERO SEMPLICE, MANEGGEVOLE**  
**PRECISE, STURDY, VERSATILE, LIGHT, HANDY, SIMPLE**



**Alcuni esempi d'impiego**  
**Examples of use**

Articolo/Item	Dimensioni/Dimension
ANGOLFAST 45	450 mm
ANGOLFAST 70	700 mm
ANGOLFAST 70S	700 mm con battuta/with reference shoulder



**Angolfast 70S** con battuta di riferimento per agevolare la tracciatura  
**Angolfast 70S** with reference shoulder for easier outlining

## TRIMATIC 43/0 FORATURA SCATOLA CREMONESE/DRILLING FOR CREMONE BOLTS

Si rivolge ai serramentisti che hanno problemi nella foratura per l'inserimento della maniglia nell'infisso in legno, legno/alluminio e PVC. Il **TRIMATIC 43/0** consente con un normale trapano a colonna o un trapano elettrico portatile di fare in una sola passata i tre fori necessari al fissaggio della scatola cremonese. Il **TRIMATIC 43/0** è un'attrezzatura di foratura per maniglie con interasse delle viti di fissaggio di 43 mm.

**TRIMATIC 43/0** was designed for window frame makers who have problems with drilling holes to fit the handle on wood, wood/aluminium and PVC windows. **TRIMATIC 43/0** allows drilling the three holes necessary to fit the cremone bolt in one single pass with a normal pillar drill or a portable electric drill. **TRIMATIC 43/0**, a drilling jig for handles with a distance between centres of the retaining screws of 43 mm.

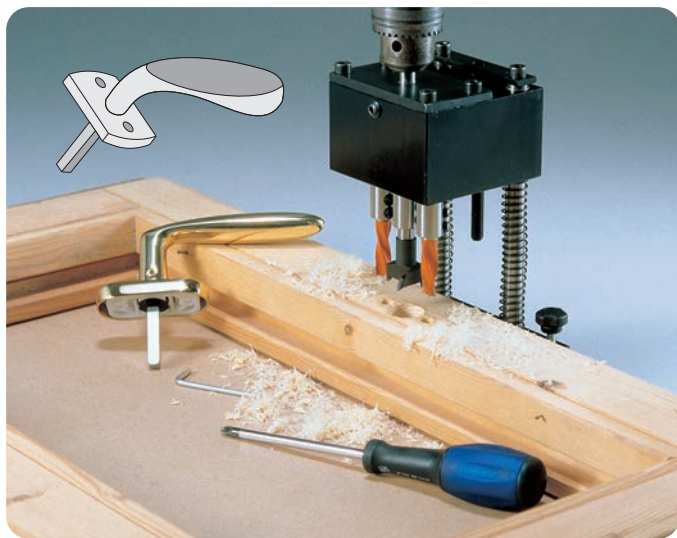

Articolo/Item  
TRIMATIC 43/0



Attenzione la punta centrale ha rotazione destra e le punte laterali hanno rotazione sinistra.  
The central bit must have right hand rotation, the lateral bits have left hand rotation.

Foratura di finestre in legno e PVC per inserire la scatola cremonese  
Drilling of wood and PVC window frames to fit cremone bolts

Punte in HSS per attrezzature  
**TRIMATIC 43/0** per forare PVC e Alluminio  
HSS tools suitable for  
**TRIMATIC 43/0** for working PVC and Aluminium

Ø	Rotazione/Rotation	Descrizione/Description
8	Sx/Lh	U260.080.L
10	Sx/Lh	U260.100.L
12	Dx/Rh	U260.120.R
12	Sx/Lh	U260.120.L
14	Dx/Rh	U260.140.R

Schema di foratura di alcune ferramenta  
Some examples of drilling patterns

SIEGENIA-TRIAL		WEIDTMANN-KURLER	
U260.120.L	2	U260.100.L	2
U260.120.R	1	U260.140.R	1
G-U JET77		OLIVEN	
U260.100.L	2	U260.080.L	2
U260.120.R	1	U260.120.R	1

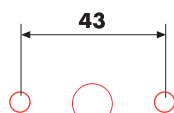
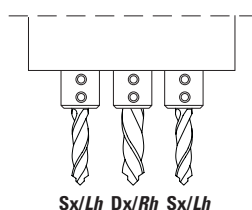

## DIMENSIONI/DIMENSIONS

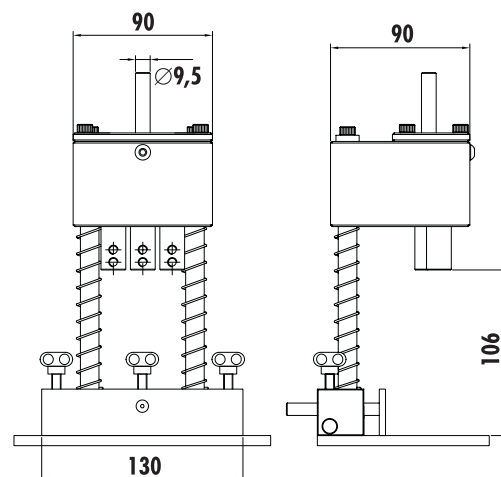

## GRUPPO PER FORATURA DI FINESTRE PER L'INSERIMENTO DELLA SCATOLA CREMONESE DRILLING OF WOOD AND PVC WINDOW FRAME TO FIT CREMONE BOLT

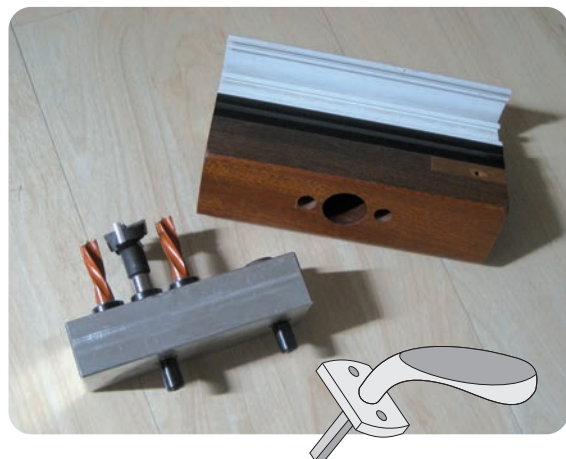

Articolo/Item  
TRIMATIC SUPER 43/0

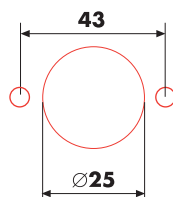

Il **TRIMATIC SUPER 43/0** viene facilmente montato su una qualsiasi macchina foratrice con mandrini in linea che hanno distanza di interasse 32 mm. Garantisce una estrema precisione e rapidità di esecuzione, permettendo di eseguire in una sola passata i 3 fori necessari per l'inserimento della scatola cremonese.

The **TRIMATIC SUPER 43/0** can be easily installed on every multi boring machine with distance of 32 mm between each spindle. Guarantees best precision and speed of execution, making three holes in one single pass.

Punte in HW per attrezzature **TRIMATIC SUPER 43/0** per la foratura di finestre in legno e PVC per inserire la scatola cremonese  
HW tools suitable for **TRIMATIC SUPER 43/0**

Ø	Rotazione/Rotation	Descrizione/Description
10	Sx	L103.100.L
12	Sx	L103.120.L
25	Dx	L140.250.R



# Klein®

WEBSITE



**SISTEMI** S.r.l.

61122 PESARO - Via Montanelli, 70 - Italy  
Tel. +39.0721.28950 - Fax +39.0721.283476  
[www.sistemiklein.com](http://www.sistemiklein.com) - [info@sistemiklein.com](mailto:info@sistemiklein.com)

